

# WomenU21-44

Competitors: 4

## Competitors

| # | Name                 | Grade | Club                           | 1  | 2 | 3 | 4 | Wins | Pts | Pos |
|---|----------------------|-------|--------------------------------|----|---|---|---|------|-----|-----|
| 1 | PIETRZAK Zuzanna     | 3.kyu | UKS Olimp Nowa Sol             |    |   |   |   | 0    | 0   | 4   |
| 2 | POLKOWSKA Aleksandra | 2.kyu | UKS Judo Kontra Minsk Mazowiec | 10 |   |   | 1 | 3    | 21  | 1   |
| 3 | OLEJNIK Izabella     | 3.kyu | AZS-AWF Poznan                 | 10 |   |   |   | 1    | 10  | 3   |
| 4 | STOKLOSA Natalia     | 1.kyu | MUKS KOKORO lodz               | 10 |   | 1 |   | 2    | 11  | 2   |

## Matches

| Match | White                | Blue                     | Result | Time |
|-------|----------------------|--------------------------|--------|------|
| 1     | PIETRZAK Zuzanna     | 1 2 POLKOWSKA Aleksandra | 00-10  | 0:14 |
| 2     | OLEJNIK Izabella     | 3 4 STOKLOSA Natalia     | 00-01  | 4:00 |
| 3     | PIETRZAK Zuzanna     | 1 3 OLEJNIK Izabella     | 00-12  | 1:04 |
| 4     | POLKOWSKA Aleksandra | 2 4 STOKLOSA Natalia     | 01-00  | 4:00 |
| 5     | PIETRZAK Zuzanna     | 1 4 STOKLOSA Natalia     | 00-10  | 2:17 |
| 6     | POLKOWSKA Aleksandra | 2 3 OLEJNIK Izabella     | 11-00  | 2:35 |

## Results

| Pos | Name   |
|-----|--|
| 1   | POLKOWSKA Aleksandra, UKS Judo Kontra Minsk Mazowiec |
| 2   | STOKLOSA Natalia, MUKS KOKORO lodz                   |
| 3   | OLEJNIK Izabella, AZS-AWF Poznan                     |
| 4   | PIETRZAK Zuzanna, UKS Olimp Nowa Sol                 |

# WomenU21-48

Competitors: 5

## Competitors

| # | Name                | Grade | Club   | 1  | 2  | 3 | 4  | 5 | Wins | Pts | Pos |
|---|---------------------|-------|--|----|----|---|----|---|------|-----|-----|
| 1 | KICEK Angelika      | 3.kyu | UKS Olimp Nowa Sol                             |    |    |   |    |   | 0    | 0   | 5   |
| 2 | OLEJNIK Anna        | 3.kyu | UKS Gimnazjon Suchy Las                        | 10 |    |   |    |   | 1    | 10  | 4   |
| 3 | JANECZKO Aleksandra | 3.kyu | UKJ ARCUS Warszawa                             | 10 | 10 |   |    | 0 | 3    | 20  | 2   |
| 4 | APRAKSIN Martyna    | 1.kyu | Klub Judo Politechniki Bialostockiej Bialystok | 10 |    |   |    |   | 3    | 12  | 3   |
| 5 | OLCZYK Monika       | 3.kyu | UKS SAKURA Judo Plock Plock                    | 10 | 10 |   | 10 |   | 3    | 30  | 1   |

## Matches

| Match | White               | Blue                    | Result  | Time |
|-------|---------------------|-------------------------|---------|------|
| 1     | APRAKSIN Martyna    | 4 5 OLCZYK Monika       | 00s3-11 | 1:28 |
| 2     | KICEK Angelika      | 1 2 OLEJNIK Anna        | 00s1-11 | 2:04 |
| 3     | JANECZKO Aleksandra | 3 4 APRAKSIN Martyna    | 00-01s2 | 5:00 |
| 4     | KICEK Angelika      | 1 5 OLCZYK Monika       | 01s1-14 | 4:00 |
| 5     | OLEJNIK Anna        | 2 3 JANECZKO Aleksandra | 00-10s1 | 5:22 |
| 6     | KICEK Angelika      | 1 4 APRAKSIN Martyna    | 00s2-11 | 2:44 |
| 7     | JANECZKO Aleksandra | 3 5 OLCZYK Monika       | 00-00s1 | 5:46 |
| 8     | OLEJNIK Anna        | 2 4 APRAKSIN Martyna    | 01-02   | 4:00 |
| 9     | KICEK Angelika      | 1 3 JANECZKO Aleksandra | 00-10   | 0:00 |
| 10    | OLEJNIK Anna        | 2 5 OLCZYK Monika       | 01-10   | 2:15 |

## Results

| Pos | Name   |
|-----|--|
| 1   | OLCZYK Monika, UKS SAKURA Judo Plock Plock                       |
| 2   | JANECZKO Aleksandra, UKJ ARCUS Warszawa                          |
| 3   | APRAKSIN Martyna, Klub Judo Politechniki Bialostockiej Bialystok |
| 4   | OLEJNIK Anna, UKS Gimnazjon Suchy Las                            |
| 5   | KICEK Angelika, UKS Olimp Nowa Sol                               |

# WomenU21-52

Competitors: 7

## Competitors A

| # | Name             | Grade | Club                          | 1  | 2 | 3  | 4  | Wins | Pts | Pos |
|---|------------------|-------|-------------------------------|----|---|----|----|------|-----|-----|
| 1 | UKUS Agnieszka   | 2.kyu | GKS Czarni Bytom              |    |   | 1  | 10 | 2    | 11  | 2   |
| 2 | NOWICKA Dominika | 1.kyu | Uczniowski Klub Sportowy JUDO | 10 |   | 10 | 10 | 3    | 30  | 1   |
| 3 | NIEMIEC Wiktoria | 2.kyu | MMKS Wojownik Skierniewice    |    |   |    |    | 0    | 0   | 4   |
| 4 | RYCHERT Kamila   | 3.kyu | UKS Conrad Gdansk             |    |   | 10 |    | 1    | 10  | 3   |

## Matches A

| Match | White                | Blue             | Result  | Time |
|-------|----------------------|------------------|---------|------|
| 1     | UKUS Agnieszka 1 2   | NOWICKA Dominika | 00s1-12 | 3:07 |
| 2     | NIEMIEC Wiktoria 3 4 | RYCHERT Kamila   | 03-10   | 2:36 |
| 4     | UKUS Agnieszka 1 3   | NIEMIEC Wiktoria | 01s1-00 | 4:00 |
| 5     | NOWICKA Dominika 2 4 | RYCHERT Kamila   | 10-00   | 0:11 |
| 7     | UKUS Agnieszka 1 4   | RYCHERT Kamila   | 13-00s1 | 2:38 |
| 8     | NOWICKA Dominika 2 3 | NIEMIEC Wiktoria | 10-00s2 | 4:49 |

## Competitors B

| # | Name               | Grade | Club                       | 5  | 6 | 7  | Wins | Pts | Pos |
|---|--------------------|-------|----------------------------|----|---|----|------|-----|-----|
| 5 | WROBLEWSKA Klaudia | 2.kyu | KS Start Radom             |    |   |    | 0    | 0   | 3   |
| 6 | KALETA Aleksandra  | 1.kyu | UKS Judo Wolbrom           | 10 |   | 10 | 2    | 20  | 1   |
| 7 | SUCHECKA Gabriela  | 2.kyu | MMKS Wojownik Skierniewice |    |   |    | 1    | 1   | 2   |

## Matches B

| Match | White                  | Blue              | Result  | Time |
|-------|------------------------|-------------------|---------|------|
| 3     | WROBLEWSKA Klaudia 5 6 | KALETA Aleksandra | 00-11   | 0:15 |
| 6     | WROBLEWSKA Klaudia 5 7 | SUCHECKA Gabriela | 00-02s1 | 4:00 |
| 9     | KALETA Aleksandra 6 7  | SUCHECKA Gabriela | 10-00s1 | 0:53 |

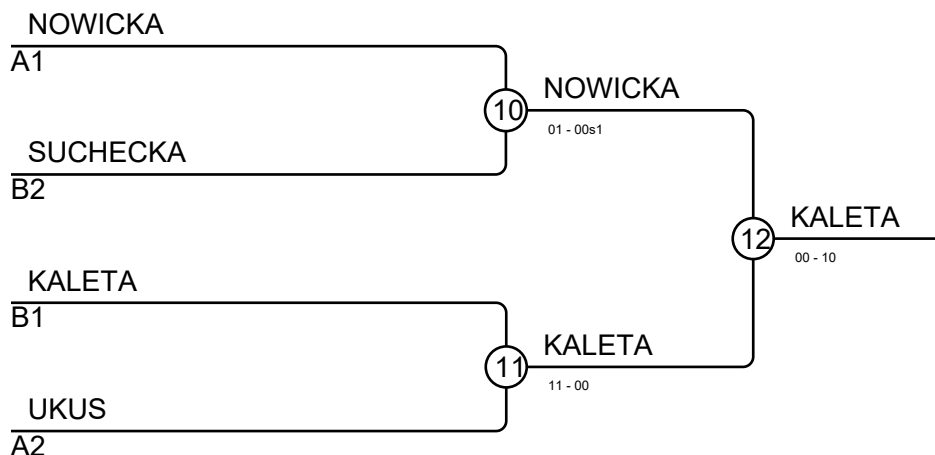

## Results

| Pos | Name  |
|-----|---|
| 1   | KALETA Aleksandra, UKS Judo Wolbrom             |
| 2   | NOWICKA Dominika, Uczniowski Klub Sportowy JUDO |
| 3   | SUCHECKA Gabriela, MMKS Wojownik Skierniewice   |
| 3   | UKUS Agnieszka, GKS Czarni Bytom                |

# WomenU21-57

Competitors: 8

## Competitors A

| # | Name                | Grade | Club                               | 1  | 2  | 3  | 4 | Wins | Pts | Pos |
|---|---------------------|-------|------------------------------------|----|----|----|---|------|-----|-----|
| 1 | MACHNICKA Vanessa   | 1.kyu | Klub Sportowy Akademia Judo Poznan | 10 | 10 |    |   | 2    | 20  | 2   |
| 2 | PRZYCZYNA Katarzyna | 1.kyu | UKS Judo Kontra Minsk Mazowiecki   |    |    | 10 |   | 1    | 10  | 3   |
| 3 | PERS Wiktoria       | 2.kyu | T.S.MOSiR Bochnia                  |    |    |    |   | 0    | 0   | 4   |
| 4 | SZYMANSKA Angelika  | 1.kyu | MKS Olimpijczyk Wloclawek          | 10 | 10 |    |   | 3    | 30  | 1   |

## Matches A

| Match | White                   | Blue                | Result  | Time |
|-------|-------------------------|---------------------|---------|------|
| 1     | MACHNICKA Vanessa 1 2   | PRZYCZYNA Katarzyna | 11-00   | 0:41 |
| 3     | PERS Wiktoria 3 4       | SZYMANSKA Angelika  | 00-10   | 0:27 |
| 5     | MACHNICKA Vanessa 1 3   | PERS Wiktoria       | 10-00   | 1:23 |
| 7     | PRZYCZYNA Katarzyna 2 4 | SZYMANSKA Angelika  | 00s1-12 | 1:43 |
| 9     | MACHNICKA Vanessa 1 4   | SZYMANSKA Angelika  | 00-10   | 6:37 |
| 11    | PRZYCZYNA Katarzyna 2 3 | PERS Wiktoria       | 10-00   | 0:34 |

## Competitors B

| # | Name               | Grade | Club                                      | 5  | 6  | 7  | 8 | Wins | Pts | Pos |
|---|--------------------|-------|---|----|----|----|---|------|-----|-----|
| 5 | SMIETANA Katarzyna | 2.kyu | UKS Judo Team Modliborzycze Modliborzycze | 10 | 10 |    |   | 2    | 20  | 1   |
| 6 | KOZLOWSKA Ewelina  | 3.kyu | UMKS zak Kielce                           | 10 |    |    |   | 1    | 10  | 4   |
| 7 | MROZ Dominika      | 1.kyu | Klub Judo DRAKO Warszawa                  | 10 |    | 10 |   | 2    | 20  | 2   |
| 8 | NOWICKA Weronika   | 3.kyu | AZS Organizacja srodowiskowa WOP Poznan   |    |    |    |   | 1    | 10  | 3   |

## Matches B

| Match | White                  | Blue              | Result  | Time |
|-------|------------------------|-------------------|---------|------|
| 2     | SMIETANA Katarzyna 5 6 | KOZLOWSKA Ewelina | 00s1-10 | 0:07 |
| 4     | MROZ Dominika 7 8      | NOWICKA Weronika  | 11-00s1 | 0:59 |
| 6     | SMIETANA Katarzyna 5 7 | MROZ Dominika     | 10s1-00 | 3:16 |
| 8     | KOZLOWSKA Ewelina 6 8  | NOWICKA Weronika  | 01-11s1 | 1:39 |
| 10    | SMIETANA Katarzyna 5 8 | NOWICKA Weronika  | 10-00   | 0:12 |
| 12    | KOZLOWSKA Ewelina 6 7  | MROZ Dominika     | 00-10   | 0:50 |

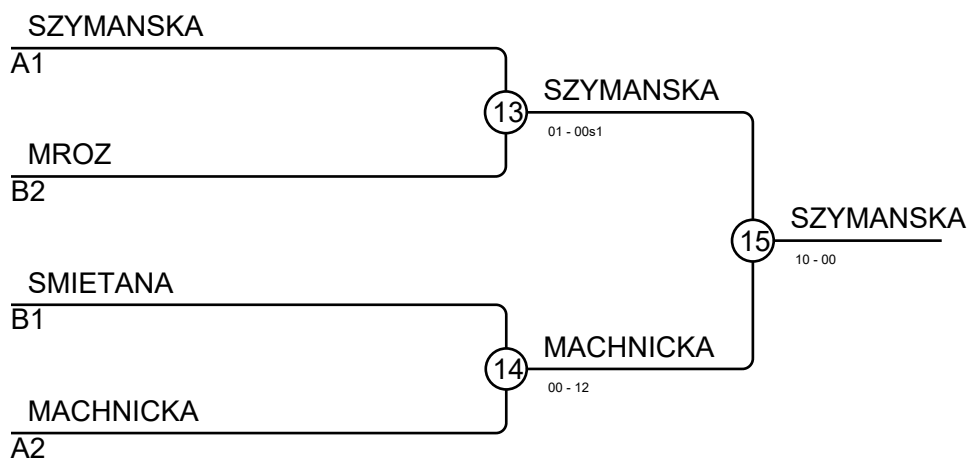

## Results

| Pos | Name  |
|-----|---|
| 1   | SZYMANSKA Angelika, MKS Olimpijczyk Wloclawek                 |
| 2   | MACHNICKA Vanessa, Klub Sportowy Akademia Judo Poznan         |
| 3   | MROZ Dominika, Klub Judo DRAKO Warszawa                       |
| 3   | SMIETANA Katarzyna, UKS Judo Team Modliborzycze Modliborzycze |

# WomenU21-63

Competitors: 13

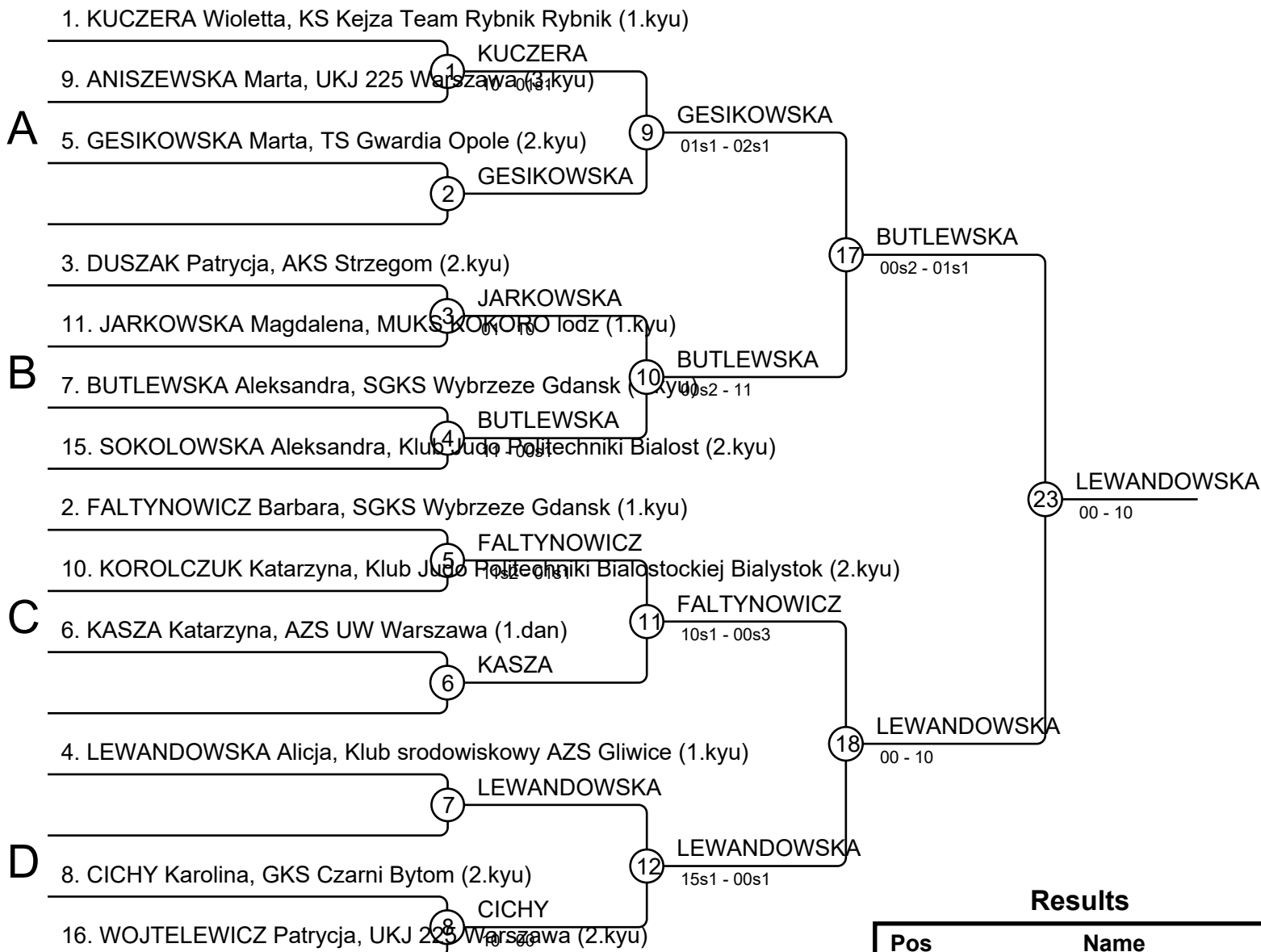

## Results

| Pos | Name                             |
|-----|----------------------------------|
| 1   | LEWANDOWSKA Alicja, Klub srodow  |
| 2   | BUTLEWSKA Aleksandra, SGKS Wyb   |
| 3   | FALTYNOWICZ Barbara, SGKS Wyb    |
| 3   | KASZA Katarzyna, AZS UW Warszav  |
| 5   | JARKOWSKA Magdalena, MUKS KO     |
| 5   | GESIKOWSKA Marta, TS Gwardia O   |
| 7   | KUCZERA Wioletta, KS Kejza Team  |
| 7   | CICHY Karolina, GKS Czarni Bytom |

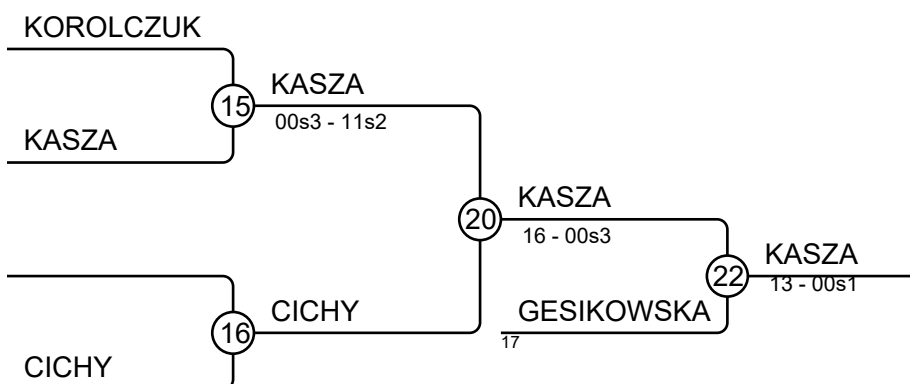
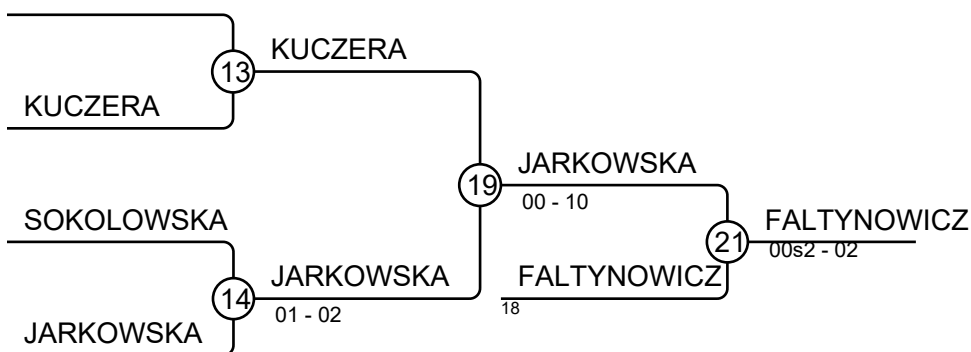

# WomenU21-70

Competitors: 11

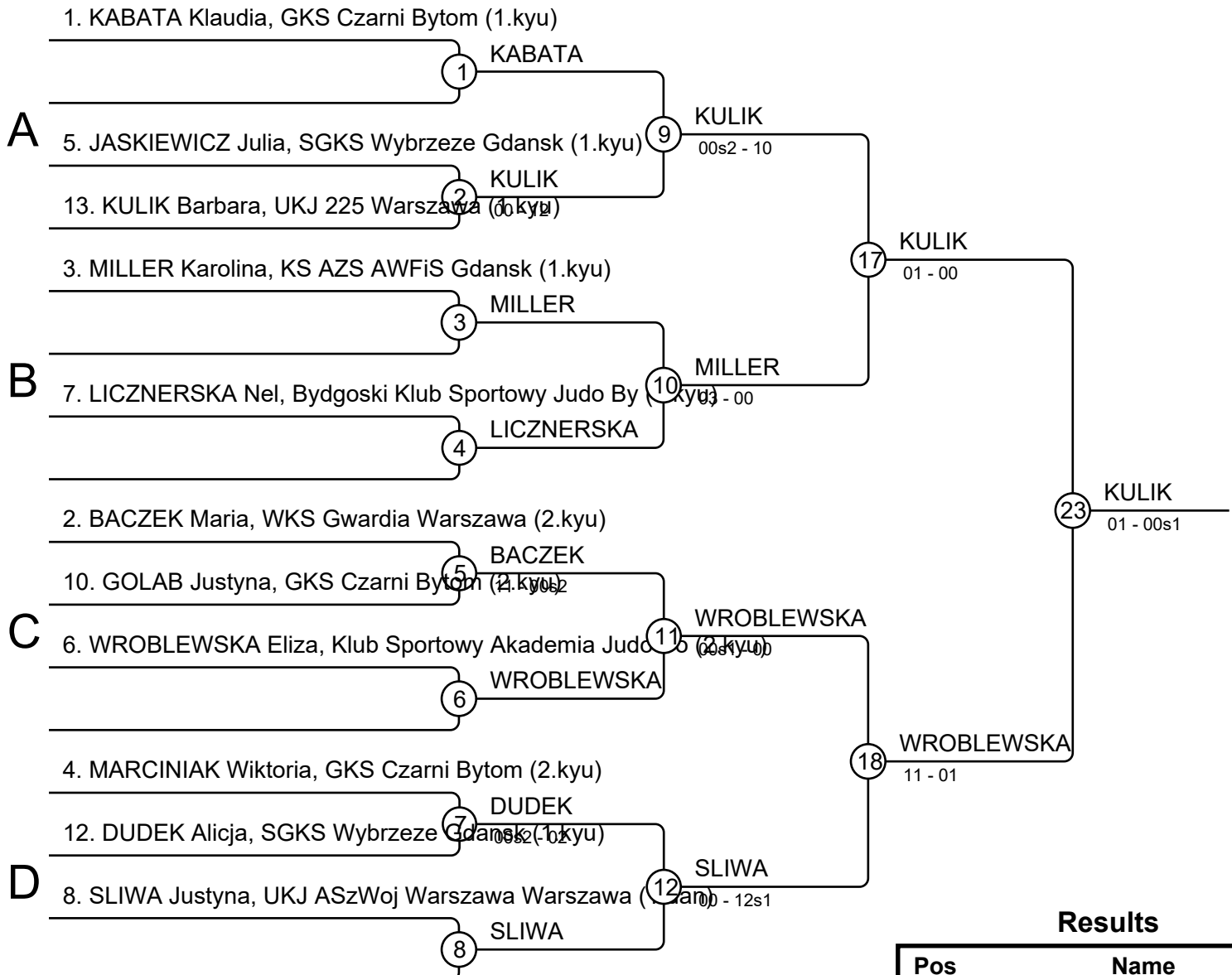

## Results

| Pos | Name                                 |
|-----|--------------------------------------|
| 1   | KULIK Barbara, UKJ 225 Warszawa      |
| 2   | WROBLEWSKA Eliza, Klub Sportowy      |
| 3   | SLIWA Justyna, UKJ ASzWoj Warszawa   |
| 3   | MILLER Karolina, KS AZS AWFIS Gdansk |
| 5   | KABATA Klaudia, GKS Czarni Bytom     |
| 5   | BACZEK Maria, WKS Gwardia Warszawa   |
| 7   | LICZNERSKA Nel, Bydgoski Klub Sp     |
| 7   | DUDEK Alicja, SGKS Wybrzeze Gdansk   |

# WomenU21-78

Competitors: 6

## Competitors A

| # | Name               | Grade | Club                     | 1  | 2  | 3 | Wins | Pts | Pos |
|---|--------------------|-------|--------------------------|----|----|---|------|-----|-----|
| 1 | CHOJNOWSKA Julia   | 3.kyu | Klub Judo DRAKO Warszawa |    |    |   | 0    | 0   | 3   |
| 2 | KOTLARSKA Dominika | 3.kyu | UMKS zak Kielce          | 10 |    |   | 1    | 10  | 2   |
| 3 | DZIOPA Paulina     | 1.kyu | GKS Czarni Bytom         | 10 | 10 |   | 2    | 20  | 1   |

## Matches A

| Match | White                  | Blue               | Result  | Time |
|-------|------------------------|--------------------|---------|------|
| 1     | CHOJNOWSKA Julia 1 2   | KOTLARSKA Dominika | 00s1-10 | 1:47 |
| 3     | CHOJNOWSKA Julia 1 3   | DZIOPA Paulina     | 00-11   | 0:51 |
| 5     | KOTLARSKA Dominika 2 3 | DZIOPA Paulina     | 00-10   | 0:55 |

## Competitors B

| # | Name                | Grade | Club                  | 4 | 5  | 6  | Wins | Pts | Pos |
|---|---------------------|-------|-----------------------|---|----|----|------|-----|-----|
| 4 | TYMANN Daria        | 1.kyu | GKS Czarni Bytom      |   | 10 | 10 | 2    | 20  | 1   |
| 5 | WOZNIAK Oliwia      | 2.kyu | GKS Czarni Bytom      |   |    | 10 | 1    | 10  | 2   |
| 6 | CZARNIECKA Karolina | 2.kyu | Gwardia Bielsko-Biala |   |    |    | 0    | 0   | 3   |

## Matches B

| Match | White              | Blue                | Result  | Time |
|-------|--------------------|---------------------|---------|------|
| 2     | TYMANN Daria 4 5   | WOZNIAK Oliwia      | 11-01s2 | 3:10 |
| 4     | TYMANN Daria 4 6   | CZARNIECKA Karolina | 11s1-00 | 2:37 |
| 6     | WOZNIAK Oliwia 5 6 | CZARNIECKA Karolina | 10-00s1 | 1:48 |

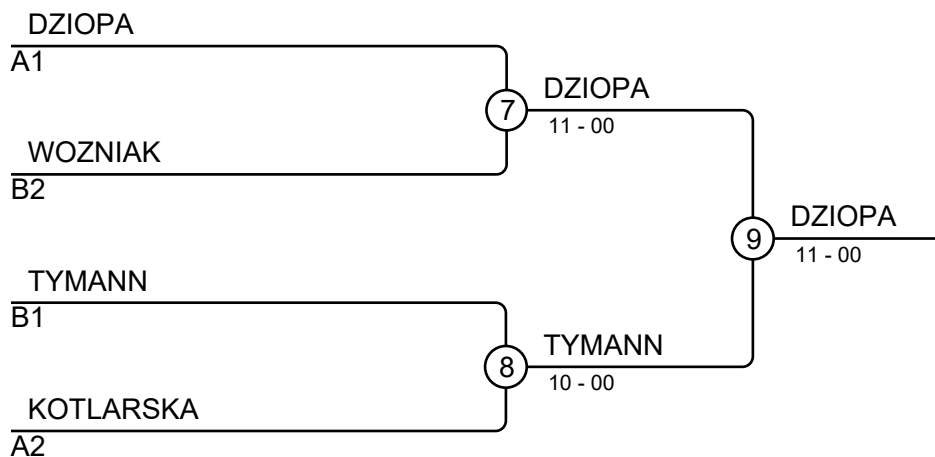

## Results

| Pos | Name                                |
|-----|-------------------------------------|
| 1   | DZIOPA Paulina, GKS Czarni Bytom    |
| 2   | TYMANN Daria, GKS Czarni Bytom      |
| 3   | WOZNIAK Oliwia, GKS Czarni Bytom    |
| 3   | KOTLARSKA Dominika, UMKS zak Kielce |

# WomenU21+78

Competitors: 2

## Competitors

| # | Name               | Grade | Club                   | 1  | 2 | Wins | Pts | Pos |
|---|--------------------|-------|------------------------|----|---|------|-----|-----|
| 1 | LIS Wiktoria       | 2.kyu | KS Budowlani Sosnowiec |    |   | 0    | 0   | 2   |
| 2 | ZAWIDZKA Agnieszka | 2.kyu | Gwardia Bielsko-Biala  | 10 |   | 1    | 10  | 1   |

## Matches

| Match | White        |   | Blue | Result             | Time      |      |
|-------|--------------|---|------|--------------------|-----------|------|
| 1     | LIS Wiktoria | 1 | 2    | ZAWIDZKA Agnieszka | 00s1-10s1 | 4:00 |

## Results

| Pos | Name                                      |
|-----|---|
| 1   | ZAWIDZKA Agnieszka, Gwardia Bielsko-Biala |
| 2   | LIS Wiktoria, KS Budowlani Sosnowiec      |



# MenU21-55

Competitors: 5

## Competitors

| # | Name               | Grade | Club                                | 1  | 2  | 3  | 4  | 5 | Wins | Pts | Pos |
|---|--------------------|-------|-------------------------------------|----|----|----|----|---|------|-----|-----|
| 1 | SLOWIKOWSKI Kacper | 1.kyu | MKS Truso Elblag                    |    | 10 | 10 | 10 |   | 3    | 30  | 2   |
| 2 | SZLEJA Gracjan     | 2.kyu | MKS Truso Elblag                    |    |    | 1  | 1  |   | 2    | 2   | 3   |
| 3 | KUBICKI Jakub      | 2.kyu | UKS Olimp Nowa Sol                  |    |    |    | 1  |   | 1    | 1   | 4   |
| 4 | NOWAK Mikolaj      | 3.kyu | AZS Organizacja srodowiskowa Poznan |    |    |    |    |   | 0    | 0   | 5   |
| 5 | PODEMSKI BENIAMIN  | 1.kyu | UKS 3 Pila                          | 10 | 10 | 10 | 10 |   | 4    | 40  | 1   |

## Matches

| Match | White              | White | Blue | Result            | Time           |
|-------|--------------------|-------|------|-------------------|----------------|
| 1     | NOWAK Mikolaj      | 4     | 5    | PODEMSKI BENIAMIN | 00s2-12 3:06   |
| 2     | SLOWIKOWSKI Kacper | 1     | 2    | SZLEJA Gracjan    | 11-00 0:00     |
| 3     | KUBICKI Jakub      | 3     | 4    | NOWAK Mikolaj     | 02-00s1 4:00   |
| 4     | SLOWIKOWSKI Kacper | 1     | 5    | PODEMSKI BENIAMIN | 00s3-12s1 2:43 |
| 5     | SZLEJA Gracjan     | 2     | 3    | KUBICKI Jakub     | 01-00s2 4:00   |
| 6     | SLOWIKOWSKI Kacper | 1     | 4    | NOWAK Mikolaj     | 11-00 0:36     |
| 7     | KUBICKI Jakub      | 3     | 5    | PODEMSKI BENIAMIN | 00-10 0:09     |
| 8     | SZLEJA Gracjan     | 2     | 4    | NOWAK Mikolaj     | 04-00 4:00     |
| 9     | SLOWIKOWSKI Kacper | 1     | 3    | KUBICKI Jakub     | 10s1-00s2 3:31 |
| 10    | SZLEJA Gracjan     | 2     | 5    | PODEMSKI BENIAMIN | 00s2-11 2:11   |

## Results

| Pos | Name   |
|-----|--|
| 1   | PODEMSKI BENIAMIN, UKS 3 Pila                      |
| 2   | SLOWIKOWSKI Kacper, MKS Truso Elblag               |
| 3   | SZLEJA Gracjan, MKS Truso Elblag                   |
| 4   | KUBICKI Jakub, UKS Olimp Nowa Sol                  |
| 5   | NOWAK Mikolaj, AZS Organizacja srodowiskowa Poznan |

# MenU21-60

Competitors: 11

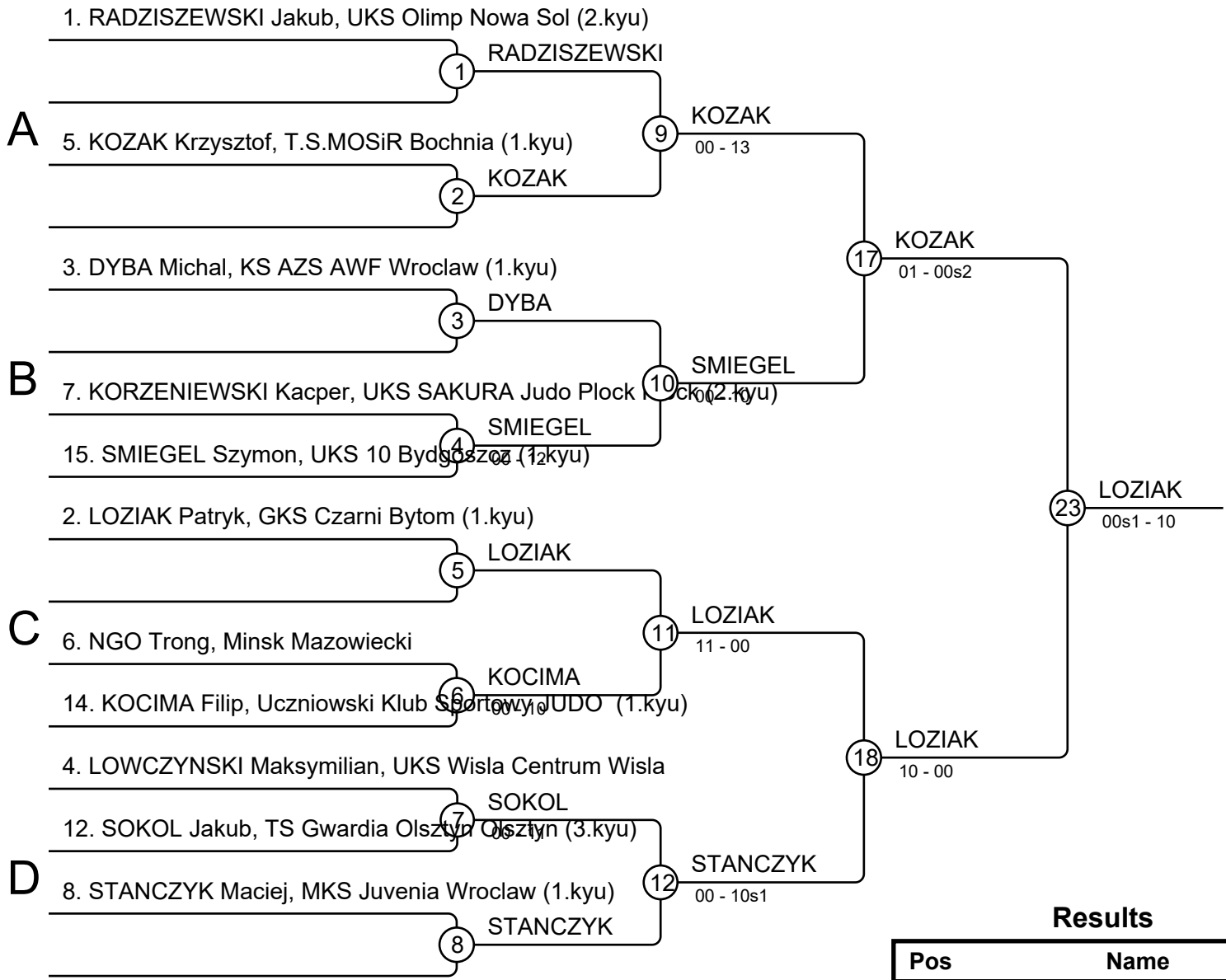

**Results**

| Pos | Name  |
|-----|---|
| 1   | LOZIAK Patryk, GKS Czarni Bytom             |
| 2   | KOZAK Krzysztof, T.S.MOSiR Bochnia          |
| 3   | STANCZYK Maciej, MKS Juvenia Wrocław        |
| 3   | SMIEGEL Szymon, UKS 10 Bydgoszcz            |
| 5   | KORZENIEWSKI Kacper, UKS SAKURA Judo Plock  |
| 5   | KOCIMA Filip, Uczniowski Klub Sportowy JUDO |
| 7   | RADZISZEWSKI Jakub, UKS Olimp Nowa Sol      |
| 7   | SOKOL Jakub, TS Gwardia Olsztyn             |

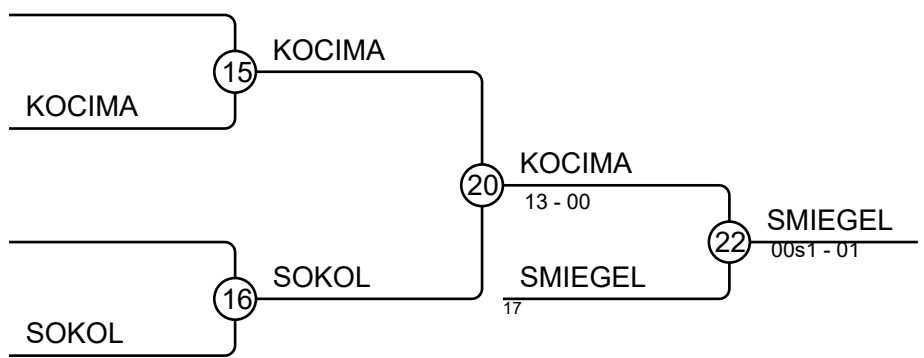
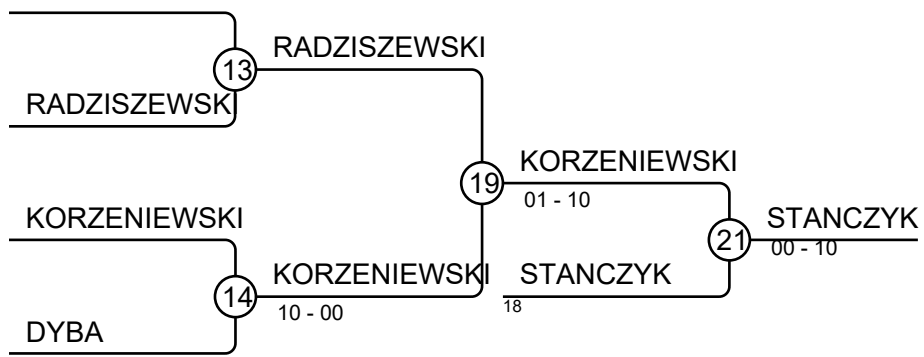

# MenU21-66

Competitors: 28

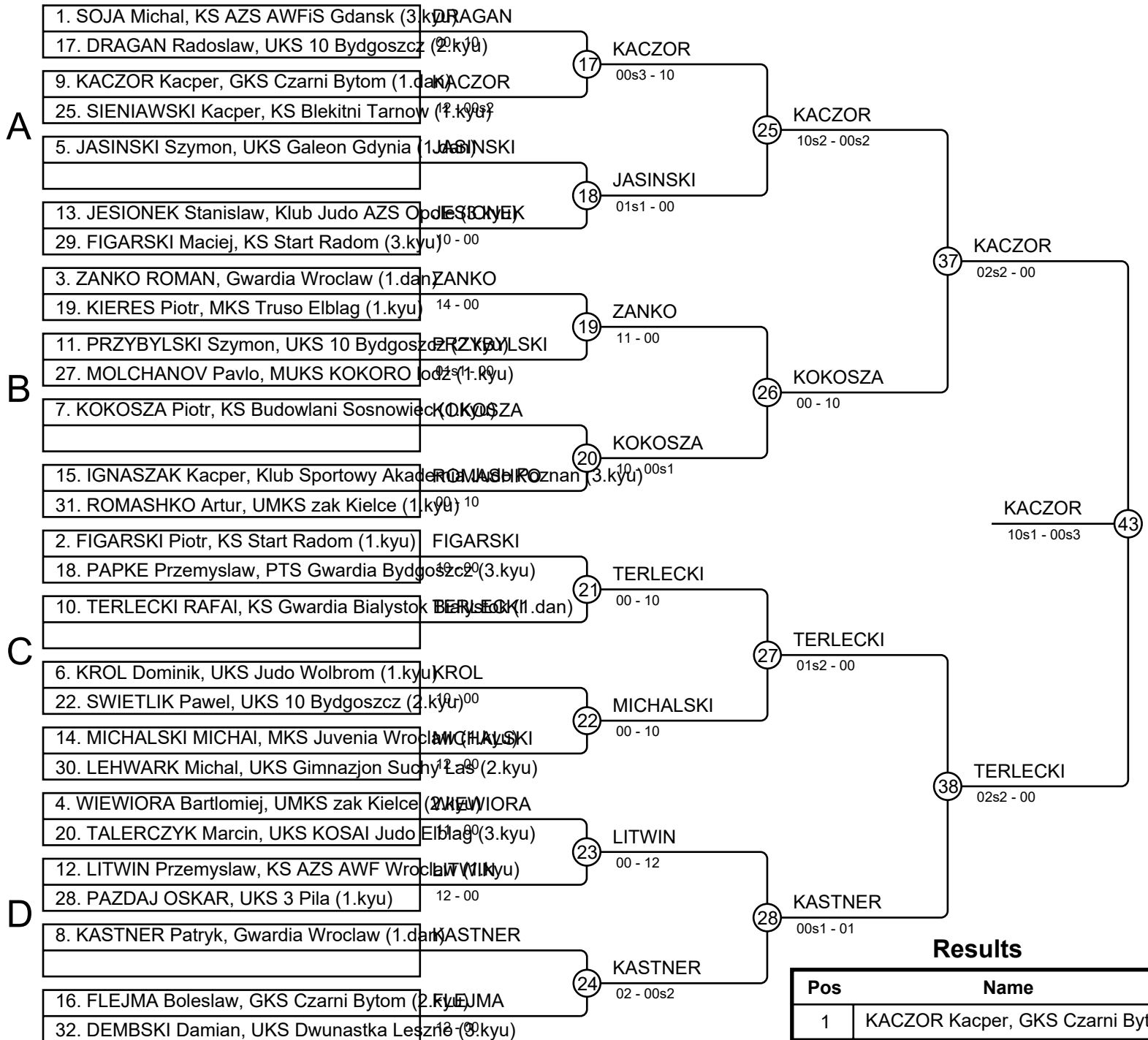

## Results

| Pos | Name                                  |
|-----|---------------------------------------|
| 1   | KACZOR Kacper, GKS Czarni Bytom       |
| 2   | TERLECKI RAFAI, KS Gwardia Bialystok  |
| 3   | KASTNER Patryk, Gwardia Wroclaw       |
| 3   | KOKOSZA Piotr, KS Budowlani Sosnowiec |
| 5   | ZANKO ROMAN, Gwardia Wroclaw          |
| 5   | LITWIN Przemyslaw, KS AZS AWF Wroclaw |
| 7   | JASINSKI Szymon, UKS Galeon Gdynia    |
| 7   | MICHALSKI MICHAJ, MKS Juvenia Wroclaw |

# MenU21-73

Competitors: 27

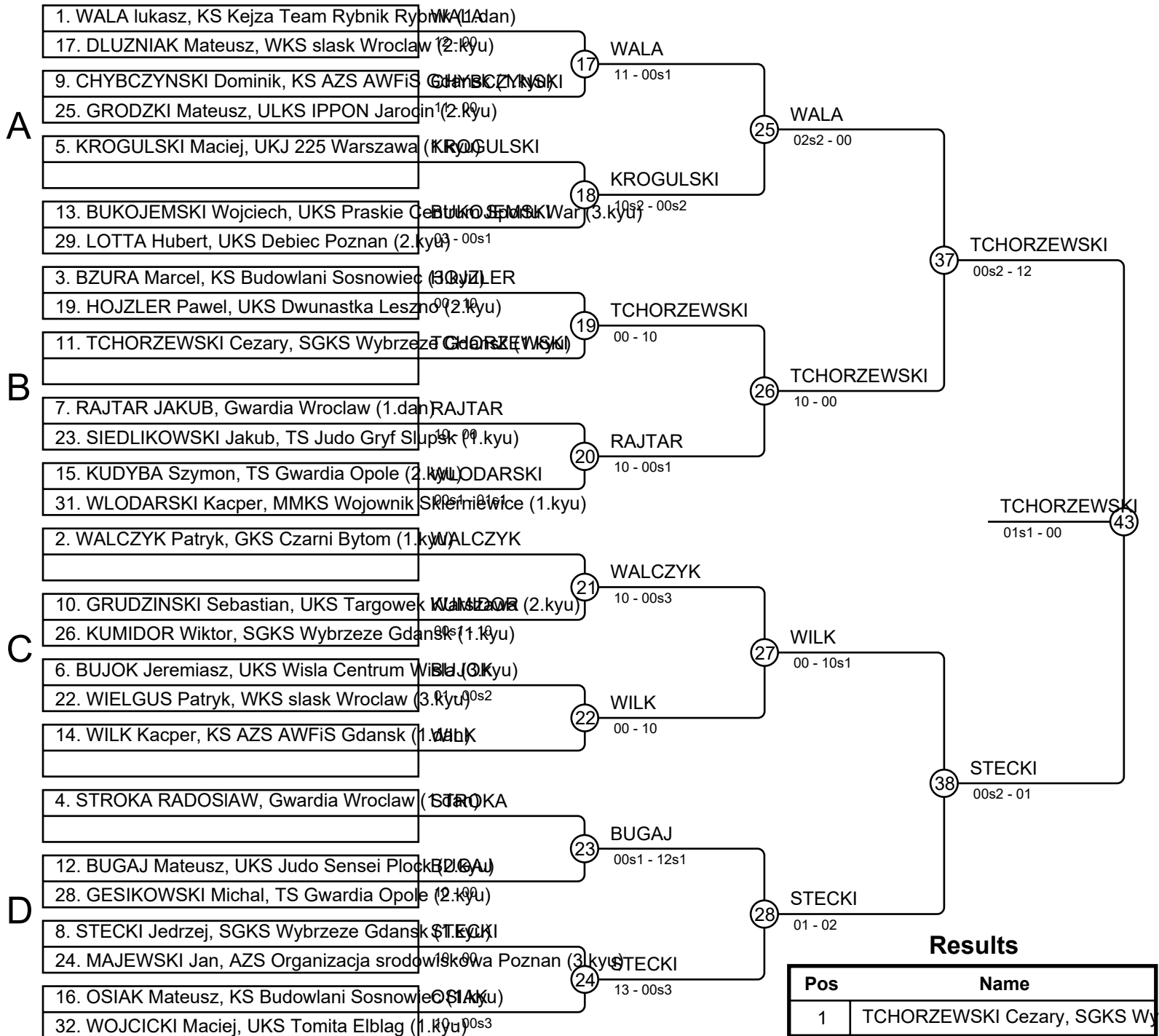

## Results

| Pos | Name                                     |
|-----|--|
| 1   | TCHORZEWSKI Cezary, SGKS Wybrzeze Gdansk |
| 2   | STECKI Jędrzej, SGKS Wybrzeze Gdansk     |
| 3   | KROGULSKI Maciej, UKJ 225 Warszawa       |
| 3   | WALCZYK Patryk, GKS Czarni Bytom         |
| 5   | WILK Kacper, KS AZS AWFIS Gdansk         |
| 5   | WALA lukasz, KS Kejza Team Rybnik Rybnik |
| 7   | RAJTAR JAKUB, Gwardia Wroclaw            |
| -7  | BUGAJ Mateusz, UKS Judo Sensei Plock     |

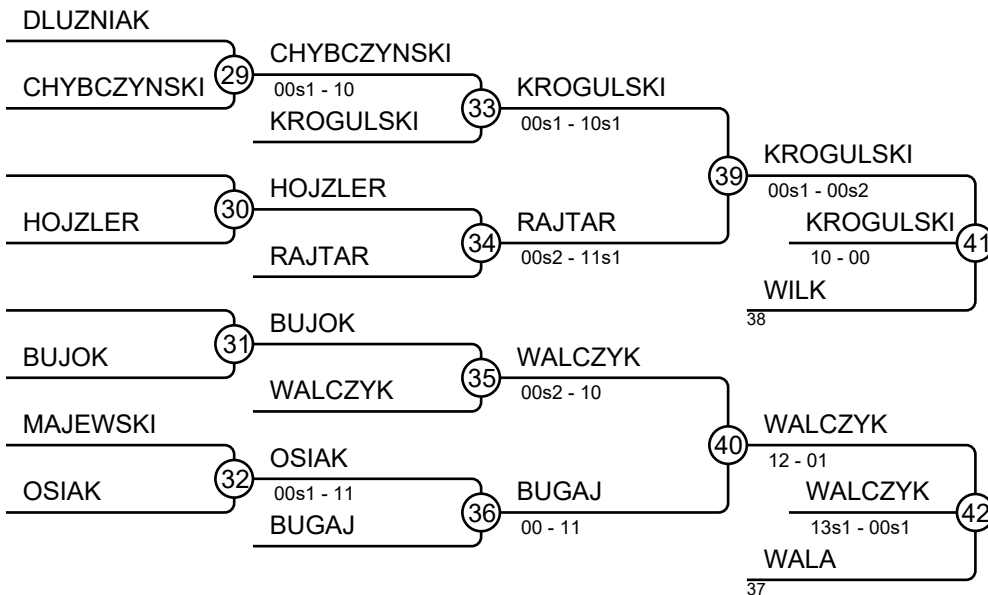

# MenU21-81

Competitors: 20

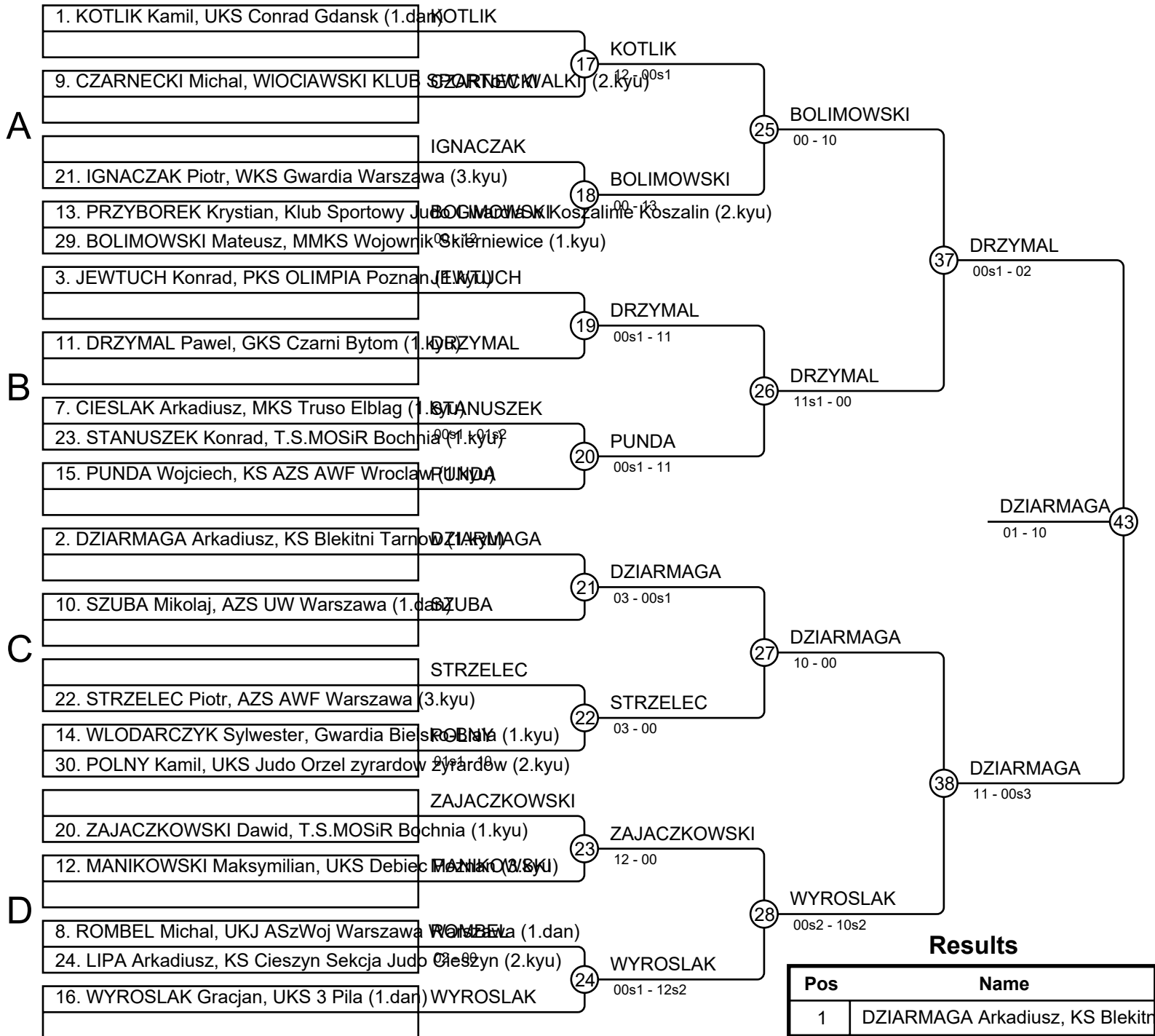

## Results

| Pos | Name  |
|-----|---|
| 1   | DZIARMAGA Arkadiusz, KS Blekitni Tarnobrzeg     |
| 2   | DRZYMAL Pawel, GKS Czarni Bytom                 |
| 3   | PUNDA Wojciech, KS AZS AWF Wroclaw              |
| 3   | BOLIMOWSKI Mateusz, MMKS Wojownik Skierzniewice |
| 5   | WYROSLAK Gracjan, UKS 3 Pila                    |
| 5   | SZUBA Mikolaj, AZS UW Warszawa                  |
| 7   | KOTLIK Kamil, UKS Conrad Gdansk                 |
| -7  | ROMBEL Michal, UKJ ASzWoj Warszawa Wolska       |

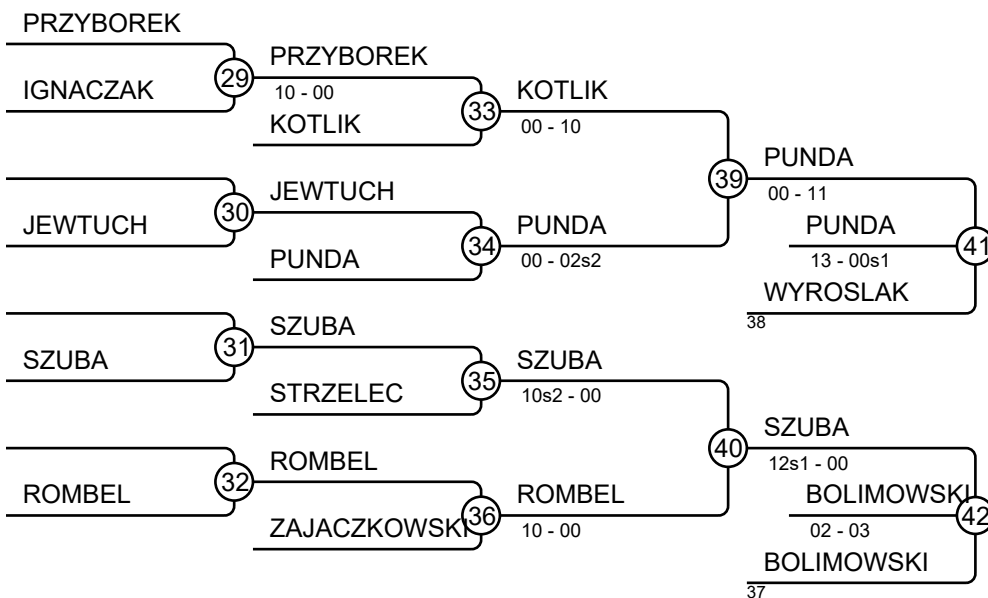

# MenU21-90

Competitors: 9

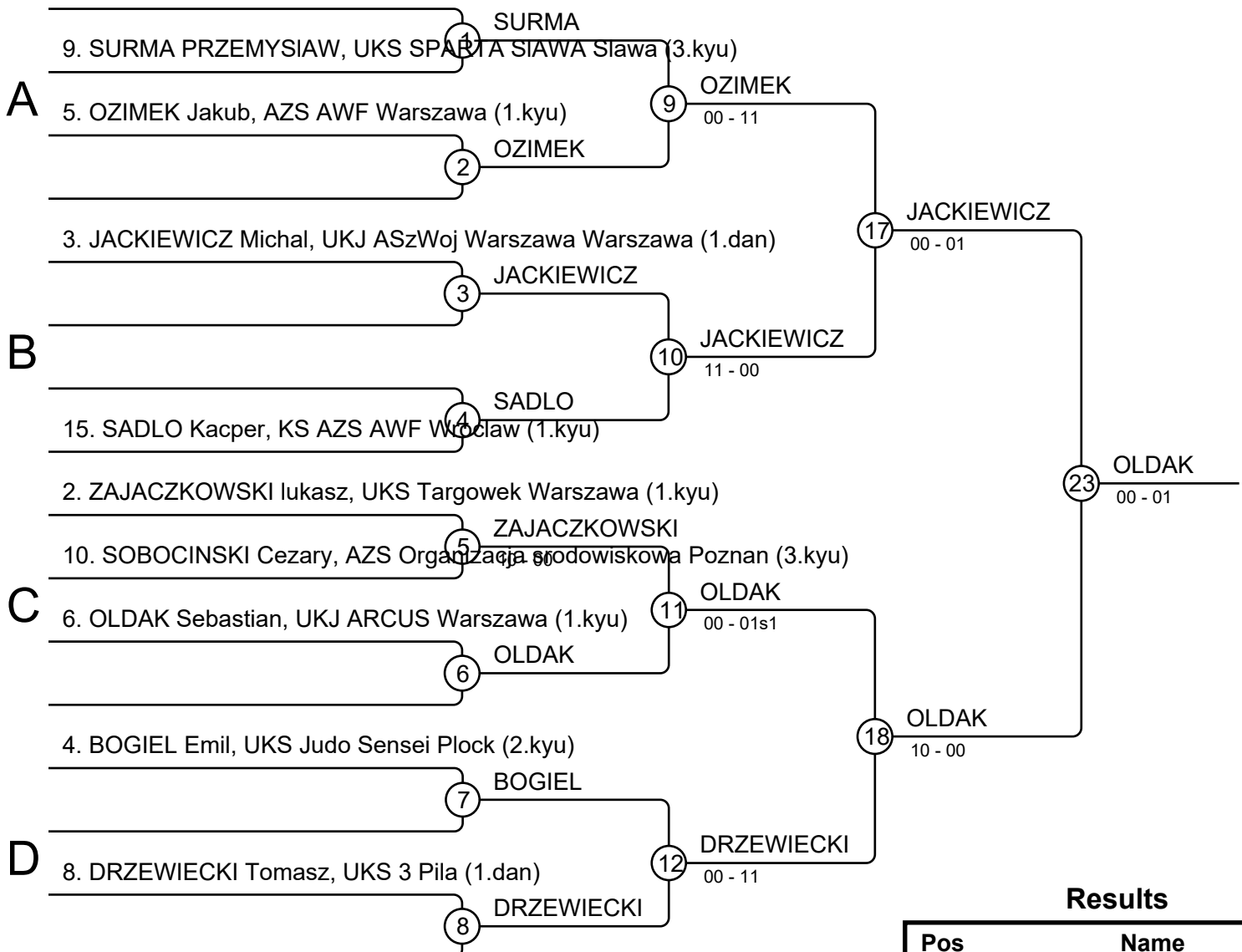

## Results

| Pos | Name                                       |
|-----|--|
| 1   | OLDAK Sebastian, UKJ ARCUS Warszawa        |
| 2   | JACKIEWICZ Michal, UKJ ASzWoj Warszawa     |
| 3   | DRZEWIECKI Tomasz, UKS 3 Pila              |
| 3   | OZIMEK Jakub, AZS AWF Warszawa             |
| 5   | SADLO Kacper, KS AZS AWF Wroclaw           |
| 5   | ZAJACZKOWSKI lukasz, UKS Targowek Warszawa |
| 7   | SURMA PRZEMYSIAW, UKS SPARTA Slawa Slawa   |
| 7   | BOGIEL Emil, UKS Judo Sensei Plock         |

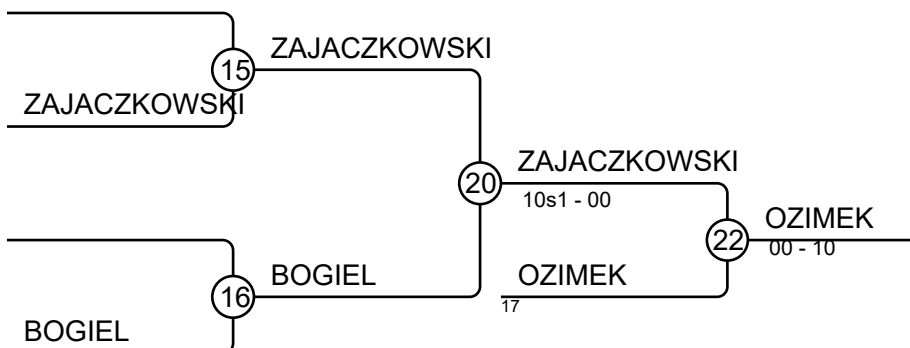
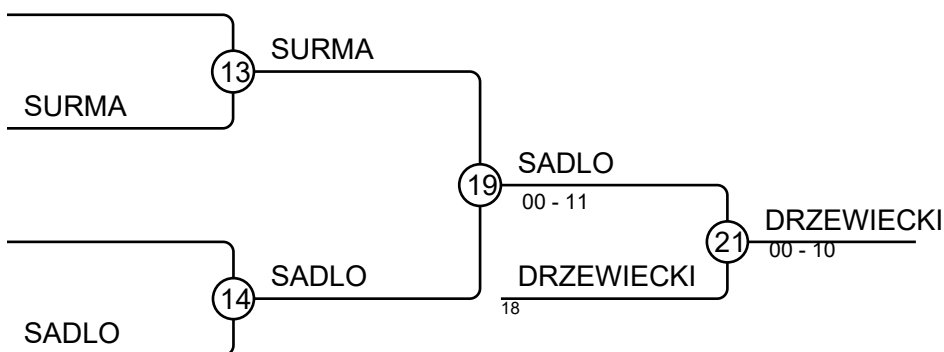

# MenU21-100

Competitors: 7

## Competitors A

| # | Name                 | Grade | Club                             | 1 | 2  | 3  | 4  | Wins | Pts | Pos |
|---|----------------------|-------|----------------------------------|---|----|----|----|------|-----|-----|
| 1 | GRZEGORZEK Milosz    | 1.kyu | Gwardia Bielsko-Biala            |   | 10 | 10 | 10 | 3    | 30  | 1   |
| 2 | KORDYALIK Grzegorz   | 3.kyu | WKS slask Wroclaw                |   |    |    |    | 0    | 0   | 4   |
| 3 | MICHALKIEWICZ MICHAŁ | 1.kyu | Klub Sportowy Judo Koch Szczecin |   |    |    | 1  | 2    | 11  | 2   |
| 4 | MOLINSKI TOMASZ      | 1.dan | Gwardia Wroclaw                  |   | 10 |    |    | 1    | 10  | 3   |

## Matches A

| Match | White                  | Blue                   | Result  | Time |
|-------|------------------------|------------------------|---------|------|
| 1     | GRZEGORZEK Milosz 1    | KORDYALIK Grzegorz 2   | 11-00   | 1:17 |
| 2     | MICHALKIEWICZ MICHAŁ 3 | MOLINSKI TOMASZ 4      | 02-01   | 4:00 |
| 4     | GRZEGORZEK Milosz 1    | MICHALKIEWICZ MICHAŁ 3 | 10-00s1 | 1:42 |
| 5     | KORDYALIK Grzegorz 2   | MOLINSKI TOMASZ 4      | 00-11   | 0:24 |
| 7     | GRZEGORZEK Milosz 1    | MOLINSKI TOMASZ 4      | 10-01   | 2:19 |
| 8     | KORDYALIK Grzegorz 2   | MICHALKIEWICZ MICHAŁ 3 | 00-11s1 | 1:26 |

## Competitors B

| # | Name             | Grade | Club                        | 5 | 6 | 7  | Wins | Pts | Pos |
|---|------------------|-------|-----------------------------|---|---|----|------|-----|-----|
| 5 | BARANIEWSKI Iwo  | 3.kyu | UKJ 225 Warszawa            |   | 1 | 10 | 2    | 11  | 1   |
| 6 | KEJZA Pawel      | 1.dan | KS Kejza Team Rybnik Rybnik |   |   | 10 | 1    | 10  | 2   |
| 7 | MAJEWSKI Mateusz | 2.kyu | UKS Debiec Poznan           |   |   |    | 0    | 0   | 3   |

## Matches B

| Match | White             | Blue               | Result    | Time |
|-------|-------------------|--------------------|-----------|------|
| 3     | BARANIEWSKI Iwo 5 | KEJZA Pawel 6      | 01s1-00s1 | 4:00 |
| 6     | BARANIEWSKI Iwo 5 | MAJEWSKI Mateusz 7 | 11-00     | 0:26 |
| 9     | KEJZA Pawel 6     | MAJEWSKI Mateusz 7 | 10-00     | 0:00 |

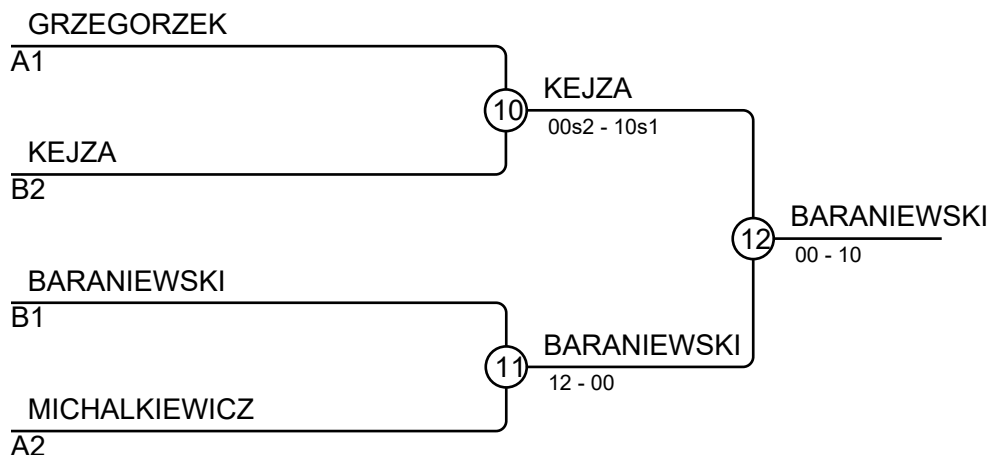

## Results

| Pos | Name   |
|-----|--|
| 1   | BARANIEWSKI Iwo, UKJ 225 Warszawa                      |
| 2   | KEJZA Pawel, KS Kejza Team Rybnik Rybnik               |
| 3   | GRZEGORZEK Milosz, Gwardia Bielsko-Biala               |
| 3   | MICHALKIEWICZ MICHAŁ, Klub Sportowy Judo Koch Szczecin |

# MenU21+100

Competitors: 9

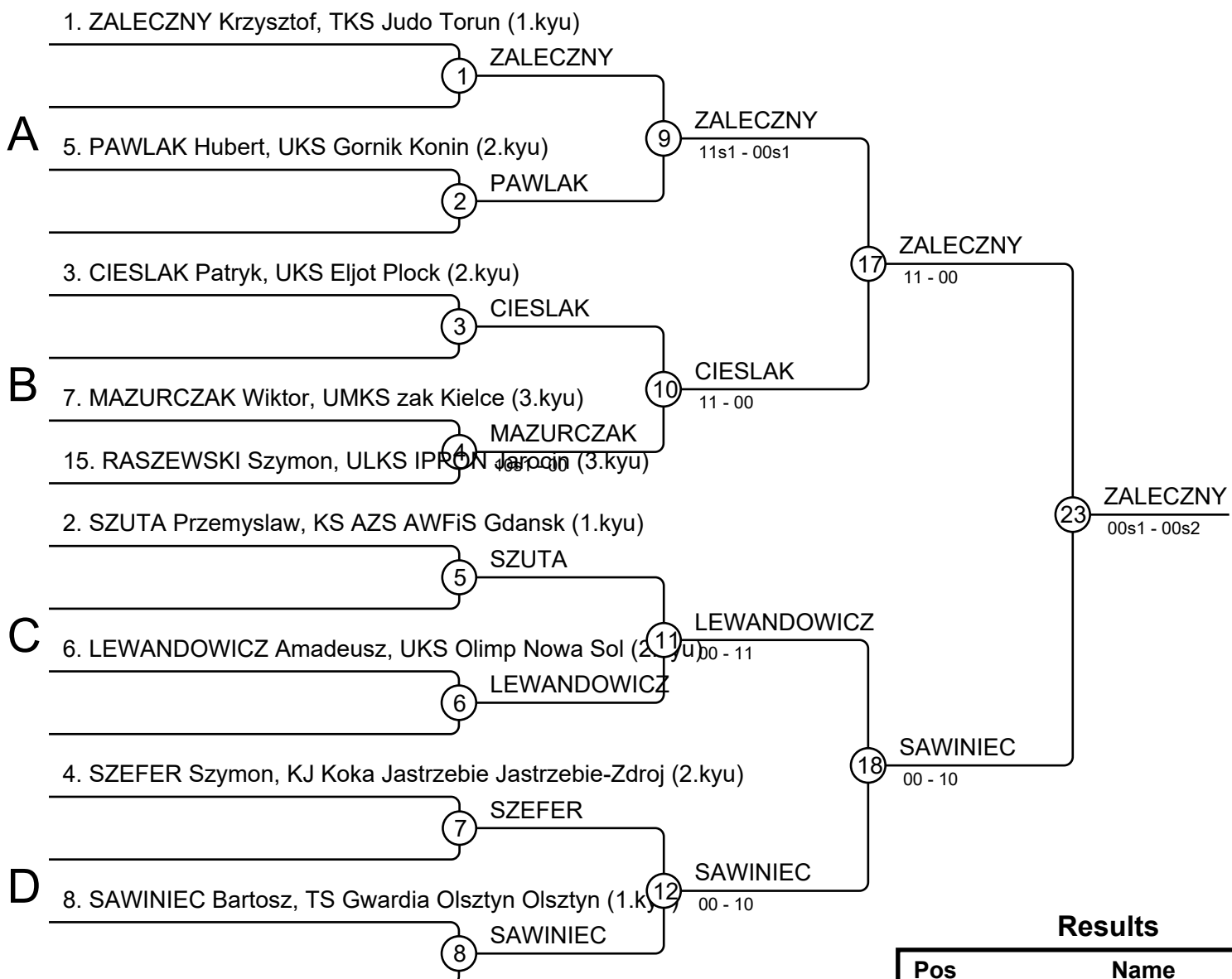

## Results

| Pos | Name                                     |
|-----|--|
| 1   | ZALECZNY Krzysztof, TKS Judo Torun       |
| 2   | SAWINIEC Bartosz, TS Gwardia Olsztyn     |
| 3   | MAZURCZAK Wiktor, UMKS zak Kielce        |
| 3   | SZUTA Przemyslaw, KS AZS AWFIS Gdansk    |
| 5   | LEWANDOWICZ Amadeusz, UKS Olimp Nowa Sol |
| 5   | CIESLAK Patryk, UKS Eljot Plock          |
| 7   | PAWLAK Hubert, UKS Gornik Konin          |
| 7   | SZEFER Szymon, KJ Koka Jastrzebie        |

