

MP 22.05.2021 Luboń F1AM1 +78

Competitors

Competitors: 1

#	Name	Grade	Club	1	Wins	Pts	Pos
1	Marcelina AUGUSTYNEK	?	UKS Maximus		0	0	1

Matches

Match	White	Blue	Result	Time
-------	-------	------	--------	------

Results

Pos	Name
1	Marcelina AUGUSTYNEK, UKS Maximus

MP 22.05.2021 Luboń M5 100kg

Competitors

Competitors: 1

#	Name	Grade	Club	1	Wins	Pts	Pos
1	Roman KACZMARCZYK	?	Klub Czech Republic		0	0	1

Matches

Match	White	Blue	Result	Time
-------	-------	------	--------	------

Results

Pos	Name
1	Roman KACZMARCZYK, Klub Czech Republic

MP 22.05.2021 Luboń F1AM2-52

Competitors

Competitors: 1

#	Name	Grade	Club	1	Wins	Pts	Pos
1	Agata ZYWERT	?	KJ GRIZZLY GDAŃSK		0	0	1

Matches

Match	White	Blue	Result	Time
-------	-------	------	--------	------

Results

Pos	Name
1	Agata ZYWERT, KJ GRIZZLY GDAŃSK

MP 22.05.2021 Luboń F1AM1-63

Competitors

Competitors: 2

#	Name	Grade	Club	1	2	1	2	1	2	Wins	Pts	Pos
1	Antonina LECHNIAK	?	UKS SPARTAKUS LUBLIN							0	0	2
2	Natalia BIŁKO	?	UKS JUDO KRAKÓW	10		10				2	20	1

Matches

Match	White			Blue	Result	Time
1	Antonina LECHNIAK	1	2	Natalia BIŁKO	00-10	2:57
2	Antonina LECHNIAK	1	2	Natalia BIŁKO	00-10	0:34
3	Antonina LECHNIAK	1	2	Natalia BIŁKO		

Results

Pos	Name
1	Natalia BIŁKO, UKS JUDO KRAKÓW
2	Antonina LECHNIAK, UKS SPARTAKUS LUBLIN

MP 22.05.2021 Luboń F1AM1-78

Competitors

Competitors: 1

#	Name	Grade	Club	1	Wins	Pts	Pos
1	Agata SKOWRON-ŚWIĘCH	?	JUDO LEGIA WARSZAWA		0	0	1

Matches

Match	White	Blue	Result	Time
-------	-------	------	--------	------

Results

Pos	Name
1	Agata SKOWRON-ŚWIĘCH, JUDO LEGIA WARSZAWA

MP 22.05.2021 Luboń M1AM1-66

Competitors

Competitors: 1

#	Name	Grade	Club	1	Wins	Pts	Pos
1	Michał REPCZYŃSKI	?	BUDOWLANI SOSNOWIEC		0	0	1

Matches

Match	White	Blue	Result	Time
-------	-------	------	--------	------

Results

Pos	Name
1	Michał REPCZYŃSKI, BUDOWLANI SOSNOWIEC

MP 22.05.2021 Luboń M1AM2-66

Competitors

Competitors: 2

#	Name	Grade	Club	1	2	1	2	1	2	Wins	Pts	Pos
1	Maciej PADOŁ	?	UKS JEDENASTKA		10		10			2	20	1
2	Krzysztof PADOŁ	?	UKS JEDENASTKA							0	0	2

Matches

Match	White			Blue	Result	Time
1	Maciej PADOŁ	1	2	Krzysztof PADOŁ	10s1-00s1	0:52
2	Maciej PADOŁ	1	2	Krzysztof PADOŁ	11-00	1:51
3	Maciej PADOŁ	1	2	Krzysztof PADOŁ		

Results

Pos	Name
1	Maciej PADOŁ, UKS JEDENASTKA
2	Krzysztof PADOŁ, UKS JEDENASTKA

MP 22.05.2021 Luboń M1AM1-73

Competitors

Competitors: 3

#	Name	Grade	Club	1	2	3	Wins	Pts	Pos
1	Jakub BIŁKO	?	TS WISŁA KRAKÓW		10	10	2	20	1
2	Karol SYGIERYCZ	?	DOJO WĄGROWIEC			10	1	10	2
3	Maciej KWIATKOWSKI	?	JUDO LEGIA WARSZAWA				0	0	3

Matches

Match	White			Blue	Result	Time
1	Jakub BIŁKO	1	2	Karol SYGIERYCZ	10-00	1:34
2	Jakub BIŁKO	1	3	Maciej KWIATKOWSKI	10-00	0:41
3	Karol SYGIERYCZ	2	3	Maciej KWIATKOWSKI	10-00s2	3:35

Results

Pos	Name
1	Jakub BIŁKO, TS WISŁA KRAKÓW
2	Karol SYGIERYCZ, DOJO WĄGROWIEC
3	Maciej KWIATKOWSKI, JUDO LEGIA WARSZAWA

MP 22.05.2021 Luboń M1AM1-81

Competitors

Competitors: 4

#	Name	Grade	Club	1	2	3	4	Wins	Pts	Pos
1	Patryk SZNAJDER	?	PIRANIE GRODZISK MAZOWIECKI					2	20	2
2	Mateusz MIZINIAK	?	KS MAKO JUDO WROCLAW			10		1	10	3
3	Patryk RAŻNY	?	UKS 10 BYDGOSZCZ				10	1	10	4
4	Karol SZESZYCKI	?	AZS UAM POZNAN	10	10			2	20	1

Matches

Match	White	Blue	Result	Time
1	Patryk SZNAJDER	Mateusz MIZINIAK	10-00s2	2:51
2	Patryk RAŻNY	Karol SZESZYCKI	11-01s3	0:55
3	Patryk SZNAJDER	Patryk RAŻNY	10-00	1:29
4	Mateusz MIZINIAK	Karol SZESZYCKI	01-10	1:37
5	Patryk SZNAJDER	Karol SZESZYCKI	00s1-10	1:09
6	Mateusz MIZINIAK	Patryk RAŻNY	10-00s1	1:06

Results

Pos	Name
1	Karol SZESZYCKI, AZS UAM POZNAN
2	Patryk SZNAJDER, PIRANIE GRODZISK MAZOWIECKI
3	Mateusz MIZINIAK, KS MAKO JUDO WROCLAW
4	Patryk RAŻNY, UKS 10 BYDGOSZCZ

MP 22.05.2021 Luboń M1AM2-81

Competitors

Competitors: 2

#	Name	Grade	Club	1	2	1	2	1	2	Wins	Pts	Pos
1	Michal RUBANOV	?	UKS SPARTAKUS LUBLIN		10		10			2	20	1
2	Karol DROZDOWSKI	?	NIE ZRZESZONO							0	0	2

Matches

Match	White			Blue	Result	Time
1	Michal RUBANOV	1	2	Karol DROZDOWSKI	10s1-00s1	1:36
2	Michal RUBANOV	1	2	Karol DROZDOWSKI	10-00	0:30
3	Michal RUBANOV	1	2	Karol DROZDOWSKI		

Results

Pos	Name
1	Michal RUBANOV, UKS SPARTAKUS LUBLIN
2	Karol DROZDOWSKI, NIE ZRZESZONO

MP 22.05.2021 Luboń M1AM1-90

Competitors

Competitors: 2

#	Name	Grade	Club	1	2	1	2	1	2	Wins	Pts	Pos
1	Konrad KŁONOWSKI	?	Olimpijczyk Włocławek		10				10	2	20	1
2	Andrzej CYGANIK	?	TS WISŁA KRAKÓW			10				1	10	2

Matches

Match	White			Blue	Result	Time
1	Konrad KŁONOWSKI	1	2	Andrzej CYGANIK	10s1-01	1:05
2	Konrad KŁONOWSKI	1	2	Andrzej CYGANIK	00-10	2:10
3	Konrad KŁONOWSKI	1	2	Andrzej CYGANIK	10-00	1:06

Results

Pos	Name
1	Konrad KŁONOWSKI, Olimpijczyk Włocławek
2	Andrzej CYGANIK, TS WISŁA KRAKÓW

MP 22.05.2021 Luboń M1AM2-90

Competitors

Competitors: 4

#	Name	Grade	Club	1	2	3	4	Wins	Pts	Pos
1	Tomasz WOSIEK	?	UKS SPARTAKUS LUBLIN		10			1	10	3
2	Jeremie NTIAKA	?	UKS JUDO KRAKÓW					0	0	4
3	Daniel CZERW	?	KS GWARDIA TYCHY	10	10		10	3	30	1
4	Dariusz KUCZMA	?	UKS JUDO KANO PŁOCK	10	10			2	20	2

Matches

Match	White	Blue	Result	Time
1	Tomasz WOSIEK 1 2	Jeremie NTIAKA	10-00s3	3:59
2	Daniel CZERW 3 4	Dariusz KUCZMA	10-00	0:48
3	Tomasz WOSIEK 1 3	Daniel CZERW	00-10	0:43
4	Jeremie NTIAKA 2 4	Dariusz KUCZMA	00-10	0:00
5	Tomasz WOSIEK 1 4	Dariusz KUCZMA	00s1-10	2:22
6	Jeremie NTIAKA 2 3	Daniel CZERW	00-10	0:00

Results

Pos	Name
1	Daniel CZERW, KS GWARDIA TYCHY
2	Dariusz KUCZMA, UKS JUDO KANO PŁOCK
3	Tomasz WOSIEK, UKS SPARTAKUS LUBLIN
4	Jeremie NTIAKA, UKS JUDO KRAKÓW

MP 22.05.2021 Luboń M1AM2-100

Competitors

Competitors: 1

#	Name	Grade	Club	1	Wins	Pts	Pos
1	Bartosz BAŃKA	?	UKS JUDO KANO PŁOCK		0	0	1

Matches

Match	White	Blue	Result	Time
-------	-------	------	--------	------

Results

Pos	Name
1	Bartosz BAŃKA, UKS JUDO KANO PŁOCK

MP 22.05.2021 Luboń F1-63

Competitors

Competitors: 2

#	Name	Grade	Club	1	2	1	2	1	2	Wins	Pts	Pos
1	Zuzanna GARLIŃSKA	?	GŁOGOWSKI KLUB JUDO		10		10			2	20	1
2	Paulina JURAS	?	GŁOGOWSKI KLUB JUDO							0	0	2

Matches

Match	White			Blue	Result	Time
1	Zuzanna GARLIŃSKA	1	2	Paulina JURAS	10-00	0:29
2	Zuzanna GARLIŃSKA	1	2	Paulina JURAS	10-00s1	0:58
3	Zuzanna GARLIŃSKA	1	2	Paulina JURAS		

Results

Pos	Name
1	Zuzanna GARLIŃSKA, GŁOGOWSKI KLUB JUDO
2	Paulina JURAS, GŁOGOWSKI KLUB JUDO

MP 22.05.2021 Luboń M1-66

Competitors

Competitors: 4

#	Name	Grade	Club	1	2	3	4	Wins	Pts	Pos
1	Tomasz KMIECIK	?	Bytowski Klub Sportów Walki					0	0	4
2	Bartłomiej BEDNARCZYK	?	KEJZA TEAM RYBNIK	10			10	2	20	2
3	Dariusz CHEŁMINIAK	?	WTJ WŁOCŁAWEK	10	1		1	3	12	1
4	Andrzej KLIMAS	?	UKS DWÓJKA RYDUŁTOWY	10				1	10	3

Matches

Match	White	White	Blue	Result	Time
1	Tomasz KMIECIK	1 2	Bartłomiej BEDNARCZYK	00-10	1:02
2	Dariusz CHEŁMINIAK	3 4	Andrzej KLIMAS	01s2-00	4:00
3	Tomasz KMIECIK	1 3	Dariusz CHEŁMINIAK	00-10	1:17
4	Bartłomiej BEDNARCZYK	2 4	Andrzej KLIMAS	10-00	1:13
5	Tomasz KMIECIK	1 4	Andrzej KLIMAS	00-10	0:19
6	Bartłomiej BEDNARCZYK	2 3	Dariusz CHEŁMINIAK	00-01s1	4:41

Results

Pos	Name
1	Dariusz CHEŁMINIAK, WTJ WŁOCŁAWEK
2	Bartłomiej BEDNARCZYK, KEJZA TEAM RYBNIK
3	Andrzej KLIMAS, UKS DWÓJKA RYDUŁTOWY
4	Tomasz KMIECIK, Bytowski Klub Sportów Walki

MP 22.05.2021 Luboń M1-73

Competitors

Competitors: 3

#	Name	Grade	Club	1	2	3	Wins	Pts	Pos
1	Bartosz CEMPURA	?	UKS JUDO KANO PŁOCK				0	0	3
2	Dominik PRZYWARA	?	ŚLĄSK WROCŁAW	10			1	10	2
3	Igor MASZKO	?	POWER DUCK AKADEMIA JUDO				2	20	1

Matches

Match	White			Blue	Result	Time
1	Bartosz CEMPURA	1	2	Dominik PRZYWARA	00-10	0:22
2	Bartosz CEMPURA	1	3	Igor MASZKO	00-10	0:38
3	Dominik PRZYWARA	2	3	Igor MASZKO	00-10s1	1:03

Results

Pos	Name
1	Igor MASZKO, POWER DUCK AKADEMIA JUDO
2	Dominik PRZYWARA, ŚLĄSK WROCŁAW
3	Bartosz CEMPURA, UKS JUDO KANO PŁOCK

MP 22.05.2021 Luboń M1-81

Competitors

Competitors: 5

#	Name	Grade	Club	1	2	3	4	5	Wins	Pts	Pos
1	Andrzej TASAREK	?	UMKS ŻAK KIELCE		1				1	1	4
2	Ariel DOLEGA	?	TKSJ TORUŃ						0	0	5
3	Daniel PRZEOR	?	Gwardia Koszalin	10	10			10	3	30	2
4	M i c h	? a	AKADEMIA WUDO ŁÓDŹ	100	10	10		Ż	4	31	1
5	Piotr POJAWA	?	KUMA JUDO WARSZAWA	10	10				2	20	3

Matches

Match	White	Blue	Result	Time
1	M i c h	Piotr POJAWA	O	01:11-00s2
2	Andrzej TASAREK	Ariel DOLEGA		01s1-00s2
3	Daniel PRZEOR	M i c h a	00-10	0M9
4	Andrzej TASAREK	Piotr POJAWA	00-11s1	2:18
5	Ariel DOLEGA	Daniel PRZEOR	00-10s1	1:38
6	Andrzej TASAREK	M i c h a	00-10	0M2
7	Daniel PRZEOR	Piotr POJAWA	10-00	2:06
8	Ariel DOLEGA	M i c h a	00-10	1M3
9	Andrzej TASAREK	Daniel PRZEOR	01-10s1	4:28
10	Ariel DOLEGA	Piotr POJAWA	00s1-10	2:29

Results

Pos	Name
1	M i c h a ł
2	Daniel PRZEOR, Gwardia Koszalin
3	Piotr POJAWA, KUMA JUDO WARSZAWA
4	Andrzej TASAREK, UMKS ŻAK KIELCE
5	Ariel DOLEGA, TKSJ TORUŃ

W O Ż N I A

MP 22.05.2021 Luboń M1-90

Competitors

Competitors: 5

#	Name	Grade	Club	1	2	3	4	5	Wins	Pts	Pos
1	Grzegorz TERMANOWSKI	?	KS JUDO GWARDIA KOSZALIN		10				1	10	4
2	Bogumił FRANK	?	MKS JUVENIA WROCLAW			10	10	10	4	40	1
3	Paul ZAREMBA	?	TS WISŁA KRAKÓW						0	0	5
4	Mateusz KWIATKOWSKI	?	JAGUAR GDAŃSK	10		10		10	3	30	2
5	Szymon NIEWODOWSKI	?	JAGUAR GDAŃSK	10		10			2	20	3

Matches

Match	White	Blue	Result	Time
1	Mateusz KWIATKOWSKI 4 5	Szymon NIEWODOWSKI	10-00	0:34
2	Grzegorz TERMANOWSKI 1 2	Bogumił FRANK	00-10	0:47
3	Paul ZAREMBA 3 4	Mateusz KWIATKOWSKI	00-11	1:17
4	Grzegorz TERMANOWSKI 1 5	Szymon NIEWODOWSKI	00-10s1	1:33
5	Bogumił FRANK 2 3	Paul ZAREMBA	11-00	1:36
6	Grzegorz TERMANOWSKI 1 4	Mateusz KWIATKOWSKI	01-10	1:31
7	Paul ZAREMBA 3 5	Szymon NIEWODOWSKI	00-10	2:13
8	Bogumił FRANK 2 4	Mateusz KWIATKOWSKI	10-00	0:28
9	Grzegorz TERMANOWSKI 1 3	Paul ZAREMBA	11s1-00	2:33
10	Bogumił FRANK 2 5	Szymon NIEWODOWSKI	10-01s1	2:29

Results

Pos	Name
1	Bogumił FRANK, MKS JUVENIA WROCLAW
2	Mateusz KWIATKOWSKI, JAGUAR GDAŃSK
3	Szymon NIEWODOWSKI, JAGUAR GDAŃSK
4	Grzegorz TERMANOWSKI, KS JUDO GWARDIA KOSZALIN
5	Paul ZAREMBA, TS WISŁA KRAKÓW

MP 22.05.2021 Luboń M1-100

Competitors

Competitors: 1

#	Name	Grade	Club	1	Wins	Pts	Pos
1	Łukasz KOGUT	?	GŁOGOWSKI KLUB JUDO	0	0	1	

Matches

Match	White	Blue	Result	Time
-------	-------	------	--------	------

Results

Pos	Name
1	Łukasz KOGUT, GŁOGOWSKI KLUB JUDO

MP 22.05.2021 Luboń M1+100

Competitors

Competitors: 1

#	Name	Grade	Club	1	Wins	Pts	Pos
1	Szymon KOWALSKI	?	KS JUDO TEAM MASTERS	RS	0	0	1

Matches

Match	White	Blue	Result	Time
-------	-------	------	--------	------

Results

Pos	Name
1	Szymon KOWALSKI, KS JUDO TEAM MASTERS

MP 22.05.2021 Luboń F2-63

Competitors

Competitors: 1

#	Name	Grade	Club	1	Wins	Pts	Pos
1	Małgorzata PROCHOWNIK	?	UKS JUDO KRAKÓW		0	0	1

Matches

Match	White	Blue	Result	Time
-------	-------	------	--------	------

Results

Pos	Name
1	Małgorzata PROCHOWNIK, UKS JUDO KRAKÓW

MP 22.05.2021 Luboń M2-73

Competitors

Competitors: 2

#	Name	Grade	Club	1	2	1	2	1	2	Wins	Pts	Pos
1	Ireneusz ŁUKOWSKI	?	KUMA JUDO WARSZAWA		10		10			2	20	1
2	Krzysztof ZIELONKA	?	AKADEMIA JUDO SZCZECIN							0	0	2

Matches

Match	White			Blue	Result	Time
1	Ireneusz ŁUKOWSKI	1	2	Krzysztof ZIELONKA	10-00s1	0:53
2	Ireneusz ŁUKOWSKI	1	2	Krzysztof ZIELONKA	10-00	1:19
3	Ireneusz ŁUKOWSKI	1	2	Krzysztof ZIELONKA		

Results

Pos	Name
1	Ireneusz ŁUKOWSKI, KUMA JUDO WARSZAWA
2	Krzysztof ZIELONKA, AKADEMIA JUDO SZCZECIN

MP 22.05.2021 Luboń M2-81

Competitors

Competitors: 3

#	Name	Grade	Club	1	2	3	Wins	Pts	Pos
1	Vladimir KARCHAVA	?	UMKS ŻAK KIELCE		10		1	10	2
2	Michał WYRWINSKI	?	IPPON JAROCIN				0	0	3
3	Przemysław SZCZEPAŃSKI	?	WTJ WŁOCŁAWEK	10	10		2	20	1

Matches

Match	White			Blue	Result	Time
1	Vladimir KARCHAVA	1	2	Michał WYRWINSKI	11-00s1	2:03
2	Vladimir KARCHAVA	1	3	Przemysław SZCZEPAŃSKI	00-10	0:56
3	Michał WYRWINSKI	2	3	Przemysław SZCZEPAŃSKI	00-11	1:47

Results

Pos	Name
1	Przemysław SZCZEPAŃSKI, WTJ WŁOCŁAWEK
2	Vladimir KARCHAVA, UMKS ŻAK KIELCE
3	Michał WYRWINSKI, IPPON JAROCIN

MP 22.05.2021 Luboń M2-90

Competitors

Competitors: 4

#	Name	Grade	Club	1	2	3	4	Wins	Pts	Pos
1	Paweł STOPIEŃSKI	?	KJ GRIZZLY GDAŃSK				10	1	10	3
2	Mariusz WALENDZEWICZ	?	KEJZA TEAM RYBNIK	10		10	10	3	30	1
3	Łukasz LASKOWSKI	?	KS JUDO TEAM MASTERS				10	2	11	2
4	Tomasz MALINOWSKI	?	KS JUDO GWARDIA KOSZALIN					0	0	4

Matches

Match	White	Blue	Result	Time
1	Paweł STOPIEŃSKI 1 2	Mariusz WALENDZEWICZ	00-10	2:23
2	Łukasz LASKOWSKI 3 4	Tomasz MALINOWSKI	10-00	1:27
3	Paweł STOPIEŃSKI 1 3	Łukasz LASKOWSKI	00s2-01s1	5:00
4	Mariusz WALENDZEWICZ 2 4	Tomasz MALINOWSKI	11-00s1	2:31
5	Paweł STOPIEŃSKI 1 4	Tomasz MALINOWSKI	10-00	0:16
6	Mariusz WALENDZEWICZ 2 3	Łukasz LASKOWSKI	10s1-00s1	2:43

Results

Pos	Name
1	Mariusz WALENDZEWICZ, KEJZA TEAM RYBNIK
2	Łukasz LASKOWSKI, KS JUDO TEAM MASTERS
3	Paweł STOPIEŃSKI, KJ GRIZZLY GDAŃSK
4	Tomasz MALINOWSKI, KS JUDO GWARDIA KOSZALIN

MP 22.05.2021 Luboń M2-100

Competitors

Competitors: 2

#	Name	Grade	Club	1	2	1	2	1	2	Wins	Pts	Pos
1	Krzysztof SZMIT	?	KS JUDO GWARDIA KOSZALIN				10			2	20	1
2	Konrad HAN	?	MKS OLIMPIJCZYK WŁOCŁAWEK							0	0	2

Matches

Match	White			Blue	Result	Time
1	Krzysztof SZMIT	1	2	Konrad HAN	10-00s1	0:38
2	Krzysztof SZMIT	1	2	Konrad HAN	10-00	0:00
3	Krzysztof SZMIT	1	2	Konrad HAN		

Results

Pos	Name
1	Krzysztof SZMIT, KS JUDO GWARDIA KOSZALIN
2	Konrad HAN, MKS OLIMPIJCZYK WŁOCŁAWEK

MP 22.05.2021 Luboń M2+100

Competitors

Competitors: 2

#	Name	Grade	Club	1	2	1	2	1	2	Wins	Pts	Pos
1	Damian ROGALA	?	UKS 10 BYDGOSZCZ							0	0	2
2	Radosław MIŚKIEWICZ	?	KS Akademia Judo Poznań	10		10				2	20	1

Matches

Match	White			Blue	Result	Time
1	Damian ROGALA	1	2	Radosław MIŚKIEWICZ	00-10	1:31
2	Damian ROGALA	1	2	Radosław MIŚKIEWICZ	00s2-10	2:52
3	Damian ROGALA	1	2	Radosław MIŚKIEWICZ		

Results

Pos	Name
1	Radosław MIŚKIEWICZ, KS Akademia Judo Poznań
2	Damian ROGALA, UKS 10 BYDGOSZCZ

MP 22.05.2021 Luboń F3-57

Competitors: 0

MP 22.05.2021 Luboń M3-73

Competitors

Competitors: 4

#	Name	Grade	Club	1	2	3	4	Wins	Pts	Pos
1	Adam LEWANDOWSKI	?	KS JUDO GWARDIA KOSZALIN				10	1	10	3
2	Sebastian LASKOWSKI	?	KS JUDO TEAM MASTERS	10			10	3	30	1
3	Karel BENAK	?	SK JUDO TEPLICE	10			10	2	20	2
4	Bartosz PYRZEWSKI	?						0	0	4

Matches

Match	White	Blue	Result	Time
1	Adam LEWANDOWSKI 1 2	Sebastian LASKOWSKI	00-10	1:36
2	Karel BENAK 3 4	Bartosz PYRZEWSKI	10-00	0:31
3	Adam LEWANDOWSKI 1 3	Karel BENAK	00s2-10	1:32
4	Sebastian LASKOWSKI 2 4	Bartosz PYRZEWSKI	10-00	1:43
5	Adam LEWANDOWSKI 1 4	Bartosz PYRZEWSKI	10-01s3	1:21
6	Sebastian LASKOWSKI 2 3	Karel BENAK	10-00	0:12

Results

Pos	Name
1	Sebastian LASKOWSKI, KS JUDO TEAM MASTERS
2	Karel BENAK, SK JUDO TEPLICE
3	Adam LEWANDOWSKI, KS JUDO GWARDIA KOSZALIN
4	Bartosz PYRZEWSKI,

MP 22.05.2021 Luboń M3-81

Competitors A

Competitors: 6

#	Name	Grade	Club	1	2	3	Wins	Pts	Pos
1	Sławomir KOŻUCH	?	GKS CZARNI BYTOM		10	10	2	20	1
2	Mariusz CZAJKOWSKI	?	AZS-AWF WARSZAWA SIOBUKAI				0	0	3
3	Damian ZAZULAK	?	YAMABUSHI ZAKOPANE		10		1	10	2

Matches A

Match	White	Blue	Result	Time
1	Sławomir KOŻUCH 1 2	Mariusz CZAJKOWSKI	10-00	0:25
3	Sławomir KOŻUCH 1 3	Damian ZAZULAK	10-00	0:46
5	Mariusz CZAJKOWSKI 2 3	Damian ZAZULAK	00-10	1:38

Competitors B

#	Name	Grade	Club	4	5	6	Wins	Pts	Pos
4	Radosław JANUCHOWSKI	?	UKS DĘBIEC JUDO POZNAŃ				0	0	3
5	Tomasz ZAWADZKI	?	KS JUDO GWARDIA KOSZALIN			10	2	20	1
6	Jacek GEMBORA	?	GKS CZARNI BYTOM	10			1	10	2

Matches B

Match	White	Blue	Result	Time
2	Radosław JANUCHOWSKI 4 5	Tomasz ZAWADZKI	00-10	0:49
4	Radosław JANUCHOWSKI 4 6	Jacek GEMBORA	00s1-10s2	4:11
6	Tomasz ZAWADZKI 5 6	Jacek GEMBORA	10-00	0:32

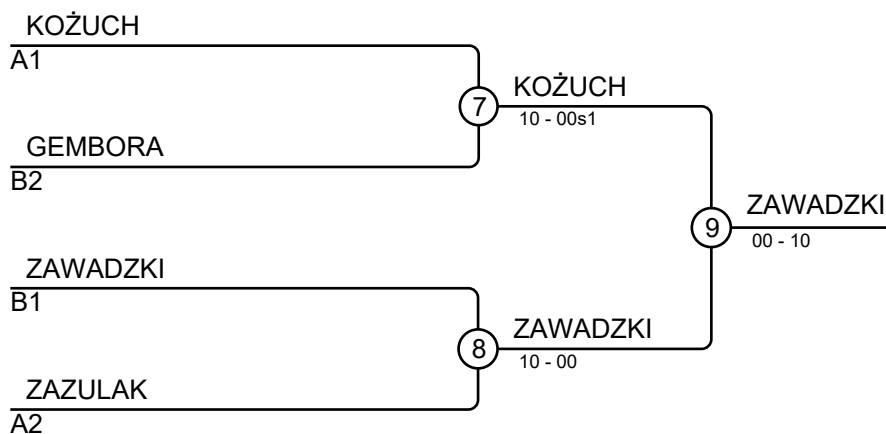

Results

Pos	Name
1	Tomasz ZAWADZKI, KS JUDO GWARDIA KOSZALIN
2	Sławomir KOŻUCH, GKS CZARNI BYTOM
3	Jacek GEMBORA, GKS CZARNI BYTOM
3	Damian ZAZULAK, YAMABUSHI ZAKOPANE

MP 22.05.2021 Luboń M3-90

Competitors

Competitors: 2

#	Name	Grade	Club	1	2	1	2	1	2	Wins	Pts	Pos
1	Giorgi GOGlichidze	?	TS Wisła Kraków		10		10			2	20	1
2	Artur ŁAGODZIŃSKI	?	IPPON JAROCIN							0	0	2

Matches

Match	White			Blue	Result	Time
1	Giorgi GOGlichidze	1	2	Artur ŁAGODZIŃSKI	10-00	0:14
2	Giorgi GOGlichidze	1	2	Artur ŁAGODZIŃSKI	10-00	0:15
3	Giorgi GOGlichidze	1	2	Artur ŁAGODZIŃSKI		

Results

Pos	Name
1	Giorgi GOGlichidze , TS Wisła Kraków
2	Artur ŁAGODZIŃSKI, IPPON JAROCIN

MP 22.05.2021 Luboń M3-100

Competitors

Competitors: 5

#	Name	Grade	Club	1	2	3	4	5	Wins	Pts	Pos
1	Witold FIJAŁKOWSKI	?	UKS KODOKAN SZCZECIN	10			10		2	20	2
2	Andrzej BOROWIEC	?	KS GWARDIA TYCHY			10	10		2	20	3
3	Łukasz MAZUR	?	POWER DUCK AKADEMIA JUDO				10		2	11	4
4	Marek DĄBEK	?	JAGUAR GDAŃSK						0	0	5
5	Roman JANISZEWSKI	?	JUDO LEGIA WARSZAWA	10	10	10			4	40	1

Matches

Match	White			Blue	Result	Time
1	Marek DĄBEK	4	5	Roman JANISZEWSKI	00s1-11	1:14
2	Witold FIJAŁKOWSKI	1	2	Andrzej BOROWIEC	10-00s1	1:10
3	Łukasz MAZUR	3	4	Marek DĄBEK	10-00	1:47
4	Witold FIJAŁKOWSKI	1	5	Roman JANISZEWSKI	00-10	2:07
5	Andrzej BOROWIEC	2	3	Łukasz MAZUR	10s1-01	3:22
6	Witold FIJAŁKOWSKI	1	4	Marek DĄBEK	10-00	2:30
7	Łukasz MAZUR	3	5	Roman JANISZEWSKI	00s3-10	1:25
8	Andrzej BOROWIEC	2	4	Marek DĄBEK	10-00	0:32
9	Witold FIJAŁKOWSKI	1	3	Łukasz MAZUR	00s1-01s2	3:30
10	Andrzej BOROWIEC	2	5	Roman JANISZEWSKI	00-10	1:34

Results

Pos	Name
1	Roman JANISZEWSKI, JUDO LEGIA WARSZAWA
2	Witold FIJAŁKOWSKI, UKS KODOKAN SZCZECIN
3	Andrzej BOROWIEC, KS GWARDIA TYCHY
4	Łukasz MAZUR, POWER DUCK AKADEMIA JUDO
5	Marek DĄBEK, JAGUAR GDAŃSK

MP 22.05.2021 Luboń M3+100

Competitors

Competitors: 3

#	Name	Grade	Club	1	2	3	Wins	Pts	Pos
1	Paweł SKOCZYLAS	?	KS JUDO CZECHOWICE-DZIEDZICE				1	1	2
2	Marcin WOŹNIAK	?	UMKS ŻAK KIELCE			1	1	1	3
3	Nikola MILANOVIĆ	?	JUDO LEGIA WARSZAWA	10			1	10	1

Matches

Match	White			Blue	Result	Time
1	Paweł SKOCZYLAS	1	2	Marcin WOŹNIAK	01s1-00s2	4:30
2	Paweł SKOCZYLAS	1	3	Nikola MILANOVIĆ	00s2-10s2	4:18
3	Marcin WOŹNIAK	2	3	Nikola MILANOVIĆ	01-00s2	4:30

Results

Pos	Name
1	Nikola MILANOVIĆ, JUDO LEGIA WARSZAWA
2	Paweł SKOCZYLAS, KS JUDO CZECHOWICE-DZIEDZICE
3	Marcin WOŹNIAK, UMKS ŻAK KIELCE

MP 22.05.2021 Luboń M4-66

Competitors

Competitors: 5

#	Name	Grade	Club	1	2	3	4	5	Wins	Pts	Pos
1	Tomasz POGORZELCZYK	?	KEJZA TEAM RYBNIK						0	0	5
2	Marcin PINTARA	?	GWARDIA WARSZAWA	10			10	1	3	21	2
3	Hubert SWIECH	?	SV 08/29 FRIEDRICHSFELD	10	10		10	10	4	40	1
4	Bartłomiej WIĄCZEK	?	NASTULA CLUB	1					1	1	4
5	Sylwester SPELAK	?	UMKS ŻAK KIELCE	0			1		2	1	3

Matches

Match	White	Blue	Result	Time
1	Bartłomiej WIĄCZEK 4 5	Sylwester SPELAK	00-01	3:30
2	Tomasz POGORZELCZYK 1 2	Marcin PINTARA	00-10s1	2:00
3	Hubert SWIECH 3 4	Bartłomiej WIĄCZEK	10-00s1	2:34
4	Tomasz POGORZELCZYK 1 5	Sylwester SPELAK	0-0	0:00
5	Marcin PINTARA 2 3	Hubert SWIECH	00s3-10s2	3:53
6	Tomasz POGORZELCZYK 1 4	Bartłomiej WIĄCZEK	00-01	3:30
7	Hubert SWIECH 3 5	Sylwester SPELAK	10-00	1:21
8	Marcin PINTARA 2 4	Bartłomiej WIĄCZEK	10-00	0:29
9	Tomasz POGORZELCZYK 1 3	Hubert SWIECH	00-10	1:00
10	Marcin PINTARA 2 5	Sylwester SPELAK	01-00s2	3:30

Results

Pos	Name
1	Hubert SWIECH, SV 08/29 FRIEDRICHSFELD
2	Marcin PINTARA, GWARDIA WARSZAWA
3	Sylwester SPELAK, UMKS ŻAK KIELCE
4	Bartłomiej WIĄCZEK, NASTULA CLUB
5	Tomasz POGORZELCZYK, KEJZA TEAM RYBNIK

MP 22.05.2021 Luboń M4-73

Competitors

Competitors: 3

#	Name	Grade	Club	1	2	3	Wins	Pts	Pos
1	Krzysztof KACZMAREK	?	UKS DĘBIEC JUDO POZNAŃ				0	0	3
2	Jarosław MAŚLIŃSKI	?	KS MAKO JUDO WROCŁAW		10		2	20	1
3	Radosław EWKO	?	KJ SHAMO EŁK	10			1	10	2

Matches

Match	White			Blue	Result	Time
1	Krzysztof KACZMAREK	1	2	Jarosław MAŚLIŃSKI	00-11	1:30
2	Krzysztof KACZMAREK	1	3	Radosław EWKO	00-10	0:24
3	Jarosław MAŚLIŃSKI	2	3	Radosław EWKO	11-00	1:36

Results

Pos	Name
1	Jarosław MAŚLIŃSKI, KS MAKO JUDO WROCŁAW
2	Radosław EWKO, KJ SHAMO EŁK
3	Krzysztof KACZMAREK, UKS DĘBIEC JUDO POZNAŃ

MP 22.05.2021 Luboń M4-81

Competitors

Competitors: 3

#	Name	Grade	Club	1	2	3	Wins	Pts	Pos
1	Marcin ŻOCHOWSKI	?	UKS CONRAD GDAŃSK		0		1	0	2
2	Emil RADZISZEWSKI	?	AZS UNIWERSYTET WARSZAWSKI				0	0	3
3	Artur PAPIS	?	PIRANIE GRODZISK MAZOWIECKI				2	20	1

Matches

Match	White			Blue	Result	Time
1	Marcin ŻOCHOWSKI	1	2	Emil RADZISZEWSKI	0-0	2:00
2	Marcin ŻOCHOWSKI	1	3	Artur PAPIS	00-10	0:19
3	Emil RADZISZEWSKI	2	3	Artur PAPIS	01-10	1:45

Results

Pos	Name
1	Artur PAPIS, PIRANIE GRODZISK MAZOWIECKI
2	Marcin ŻOCHOWSKI, UKS CONRAD GDAŃSK
3	Emil RADZISZEWSKI, AZS UNIWERSYTET WARSZAWSKI

MP 22.05.2021 Luboń M4-90

Competitors

Competitors: 4

#	Name	Grade	Club	1	2	3	4	Wins	Pts	Pos
1	Marcin BARSZCZ	?	UKS SPARTAKUS LUBLIN		10		10	2	20	2
2	Marcin FIJAŁKOWSKI	?	UKS KODOKAN SZCZECIN				10	1	10	3
3	Hakobyan WAHAN	?	KS JUDO GWARDIA KOSZALIN					2	20	1
4	Jarosław CHEŁSTOWSKI	?	AZS Uniwersytet Warszawski			10		1	10	4

Matches

Match	White	Blue	Result	Time
1	Marcin BARSZCZ 1 2	Marcin FIJAŁKOWSKI	10-00	1:39
2	Hakobyan WAHAN 3 4	Jarosław CHEŁSTOWSKI	01-10	1:16
3	Marcin BARSZCZ 1 3	Hakobyan WAHAN	00-10	1:55
4	Marcin FIJAŁKOWSKI 2 4	Jarosław CHEŁSTOWSKI	10s1-00	3:21
5	Marcin BARSZCZ 1 4	Jarosław CHEŁSTOWSKI	11s1-00s2	3:07
6	Marcin FIJAŁKOWSKI 2 3	Hakobyan WAHAN	00-11s1	1:31

Results

Pos	Name
1	Hakobyan WAHAN, KS JUDO GWARDIA KOSZALIN
2	Marcin BARSZCZ, UKS SPARTAKUS LUBLIN
3	Marcin FIJAŁKOWSKI, UKS KODOKAN SZCZECIN
4	Jarosław CHEŁSTOWSKI, AZS Uniwersytet Warszawski

MP 22.05.2021 Luboń M4-100

Competitors

Competitors: 5

#	Name	Grade	Club	1	2	3	4	5	Wins	Pts	Pos
1	Adam GRELA	?	KZ AZS AWF KATOWICE				10	10	2	20	3
2	Przemysław ZIMOWSKI	?	KS JUDO TEAM MASTERS	10			10	10	3	30	2
3	Adam PIENIAK	?	GKS CZARNI BYTOM	10	1		10	10	4	31	1
4	Arkadiusz ŚLIWA	?	TORNADO TEAM ŚWIĘTOCHŁOWICE						0	0	4
5	Marek WIKIERSKI	?	KS JUDO GWARDIA KOSZALIN						0	0	5

Matches

Match	White	White	Blue	Blue	Result	Time
1	Arkadiusz ŚLIWA	4	5	Marek WIKIERSKI	00s3-00s3	3:56
2	Adam GRELA	1	2	Przemysław ZIMOWSKI	00s2-10s1	2:40
3	Adam PIENIAK	3	4	Arkadiusz ŚLIWA	10s1-00s1	1:25
4	Adam GRELA	1	5	Marek WIKIERSKI	10-00	2:59
5	Przemysław ZIMOWSKI	2	3	Adam PIENIAK	00s1-01s2	3:30
6	Adam GRELA	1	4	Arkadiusz ŚLIWA	11s2-00s3	2:47
7	Adam PIENIAK	3	5	Marek WIKIERSKI	10-00	0:39
8	Przemysław ZIMOWSKI	2	4	Arkadiusz ŚLIWA	10s2-00s3	3:30
9	Adam GRELA	1	3	Adam PIENIAK	00-10	1:21
10	Przemysław ZIMOWSKI	2	5	Marek WIKIERSKI	10s1-00s1	1:47

Results

Pos	Name
1	Adam PIENIAK, GKS CZARNI BYTOM
2	Przemysław ZIMOWSKI, KS JUDO TEAM MASTERS
3	Adam GRELA, KZ AZS AWF KATOWICE
4	Arkadiusz ŚLIWA, TORNADO TEAM ŚWIĘTOCHŁOWICE
5	Marek WIKIERSKI, KS JUDO GWARDIA KOSZALIN

MP 22.05.2021 Luboń M4+100

Competitors

Competitors: 1

#	Name	Grade	Club	1	Wins	Pts	Pos
1	Jacek SZMATLOCH	?	GKS CZARNI BYTOM		0	0	1

Matches

Match	White	Blue	Result	Time
-------	-------	------	--------	------

Results

Pos	Name
1	Jacek SZMATLOCH, GKS CZARNI BYTOM

MP 22.05.2021 Luboń M5-66

Competitors

Competitors: 1

#	Name	Grade	Club	1	Wins	Pts	Pos
1	Krzysztof CZUPRYNA	?	KEJZA TEAM RYBNIK		0	0	1

Matches

Match	White	Blue	Result	Time
-------	-------	------	--------	------

Results

Pos	Name
1	Krzysztof CZUPRYNA, KEJZA TEAM RYBNIK

MP 22.05.2021 Luboń M5-73

Competitors

Competitors: 3

#	Name	Grade	Club	1	2	3	Wins	Pts	Pos
1	Stanisław DYNDAL	?	KOLPING JAROSŁAW				0	0	3
2	Tadeusz RUSIN	?	NIE ZRZESZONO	10		10	2	20	1
3	Peter KOLESÁR	?	AC Sparta Praha Judo	10			1	10	2

Matches

Match	White			Blue	Result	Time
1	Stanisław DYNDAL	1	2	Tadeusz RUSIN	00s1-10	0:55
2	Stanisław DYNDAL	1	3	Peter KOLESÁR	00-10	0:17
3	Tadeusz RUSIN	2	3	Peter KOLESÁR	10s1-00	1:18

Results

Pos	Name
1	Tadeusz RUSIN, NIE ZRZESZONO
2	Peter KOLESÁR, AC Sparta Praha Judo
3	Stanisław DYNDAL, KOLPING JAROSŁAW

MP 22.05.2021 Luboń M5-81

Competitors

Competitors: 5

#	Name	Grade	Club	1	2	3	4	5	Wins	Pts	Pos
1	Andrzej SALISZ	?	KZ AZS AWF KATOWICE		10	10	10		3	30	2
2	Mariusz KOS	?	AZS Uniwersytet Warszawski						0	0	5
3	Tomasz CHOJNACKI	?	AKS STRZEGOM		10				1	10	4
4	Czesław POSPIESZYŃSKI	?	GALEON GDYNIA		10	10			2	20	3
5	Leszek STRYCHARZ	?	AZS GLIWICE	10	10	10	10		4	40	1

Matches

Match	White	Blue	Result	Time
1	Czesław POSPIESZYŃSKI 4 5	Leszek STRYCHARZ	00-10	0:24
2	Andrzej SALISZ 1 2	Mariusz KOS	10-00	2:11
3	Tomasz CHOJNACKI 3 4	Czesław POSPIESZYŃSKI	00-10	0:32
4	Andrzej SALISZ 1 5	Leszek STRYCHARZ	00-10	1:23
5	Mariusz KOS 2 3	Tomasz CHOJNACKI	00-10	0:00
6	Andrzej SALISZ 1 4	Czesław POSPIESZYŃSKI	10-00	0:36
7	Tomasz CHOJNACKI 3 5	Leszek STRYCHARZ	00-10	0:42
8	Mariusz KOS 2 4	Czesław POSPIESZYŃSKI	00-10	0:00
9	Andrzej SALISZ 1 3	Tomasz CHOJNACKI	10-00	1:48
10	Mariusz KOS 2 5	Leszek STRYCHARZ	00-10	0:00

Results

Pos	Name
1	Leszek STRYCHARZ, AZS GLIWICE
2	Andrzej SALISZ, KZ AZS AWF KATOWICE
3	Czesław POSPIESZYŃSKI, GALEON GDYNIA
4	Tomasz CHOJNACKI, AKS STRZEGOM
5	Mariusz KOS, AZS Uniwersytet Warszawski

MP 22.05.2021 Luboń M5-90

Competitors A

Competitors: 6

#	Name	Grade	Club	1	2	3	Wins	Pts	Pos
1	Przemysław KAMIŃSKI	?	UKS JUDO CZĘSTOCHOWA			10	1	10	2
2	Adam POŹDZIK	?	WKS FLOTA GDYNIA	10		10	2	20	1
3	Marek KOWALSKI	?	PIRANIE GRODZISK MAZOWIECKI				0	0	3

Matches A

Match	White	Blue	Result	Time
1	Przemysław KAMIŃSKI 1 2	Adam POŹDZIK	00s3-10s2	3:18
3	Przemysław KAMIŃSKI 1 3	Marek KOWALSKI	11-00s1	1:25
5	Adam POŹDZIK 2 3	Marek KOWALSKI	10-00s1	0:58

Competitors B

#	Name	Grade	Club	4	5	6	Wins	Pts	Pos
4	Leszek JAROSIŃSKI	?	UKS JUDO KANO PŁOCK			10	1	10	2
5	Krzysztof KĘDZIORA	?	KJ GRIZZLY GDAŃSK	10		10	2	20	1
6	Artur MIK	?	KJ SHAMO EŁK				0	0	3

Matches B

Match	White	Blue	Result	Time
2	Leszek JAROSIŃSKI 4 5	Krzysztof KĘDZIORA	00-10	1:39
4	Leszek JAROSIŃSKI 4 6	Artur MIK	10s1-00s1	3:01
6	Krzysztof KĘDZIORA 5 6	Artur MIK	10-00	2:20

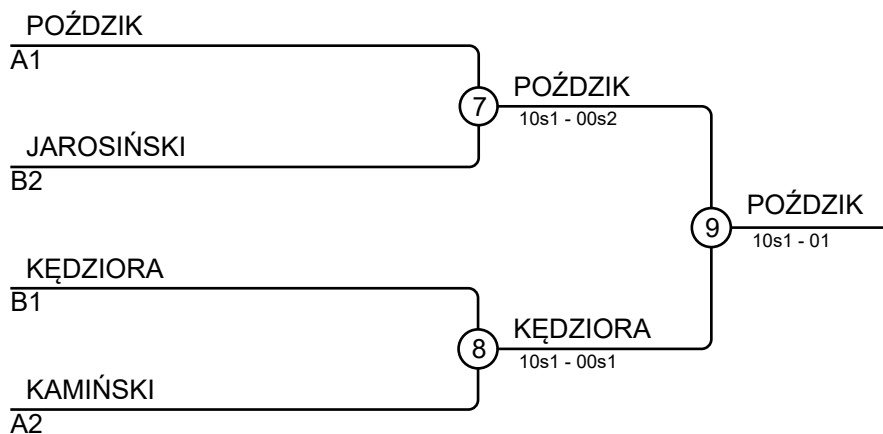

Results

Pos	Name
1	Adam POŹDZIK, WKS FLOTA GDYNIA
2	Krzysztof KĘDZIORA, KJ GRIZZLY GDAŃSK
3	Leszek JAROSIŃSKI, UKS JUDO KANO PŁOCK
3	Przemysław KAMIŃSKI, UKS JUDO CZĘSTOCHOWA

MP 22.05.2021 Luboń M5+100

Competitors

Competitors: 2

#	Name	Grade	Club	1	2	1	2	1	2	Wins	Pts	Pos
1	Dariusz MAKÓWKA	?	Commando Krav Maga Poland	10				10		2	20	1
2	Paweł KARYŚ	?	UMKS ŻAK KIELCE							0	0	2

Matches

Match	White	Blue	Result	Time
1	Dariusz MAKÓWKA	Paweł KARYŚ	10-00	1:33
2	Dariusz MAKÓWKA	Paweł KARYŚ	10s1-00s1	3:30
3	Dariusz MAKÓWKA	Paweł KARYŚ		

Results

Pos	Name
1	Dariusz MAKÓWKA, Commando Krav Maga Poland
2	Paweł KARYŚ, UMKS ŻAK KIELCE

MP 22.05.2021 Luboń M6-73

Competitors

Competitors: 1

#	Name	Grade	Club	1	Wins	Pts	Pos
1	Piotr SZYMURA	?	KEJZA TEAM RYBNIK		0	0	1

Matches

Match	White	Blue	Result	Time
-------	-------	------	--------	------

Results

Pos	Name
1	Piotr SZYMURA, KEJZA TEAM RYBNIK

MP 22.05.2021 Luboń M6-81

Competitors

Competitors: 1

#	Name	Grade	Club	1	Wins	Pts	Pos
1	Dariusz PAWŁOWSKI	?	KS JUDO GWARDIA KOSZALIN			0	1

Matches

Match	White	Blue	Result	Time
-------	-------	------	--------	------

Results

Pos	Name
1	Dariusz PAWŁOWSKI, KS JUDO GWARDIA KOSZALIN

MP 22.05.2021 Luboń M6-90

Competitors

Competitors: 2

#	Name	Grade	Club	1	2	1	2	1	2	Wins	Pts	Pos
1	Jarosław DOMOWICZ	?	MKS JUVENIA WROCLAW	10		10				2	20	1
2	Daniel BLANK	?	WKS FLOTA GDYNIA							0	0	2

Matches

Match	White			Blue	Result	Time
1	Jarosław DOMOWICZ	1	2	Daniel BLANK	10-00	1:14
2	Jarosław DOMOWICZ	1	2	Daniel BLANK	10-00	0:57
3	Jarosław DOMOWICZ	1	2	Daniel BLANK		

Results

Pos	Name
1	Jarosław DOMOWICZ, MKS JUVENIA WROCLAW
2	Daniel BLANK, WKS FLOTA GDYNIA

MP 22.05.2021 Luboń M6-100

Competitors

Competitors: 2

#	Name	Grade	Club	1	2	1	2	1	2	Wins	Pts	Pos
1	Zbigniew TARNAWSKI	?	TS WISŁA KRAKÓW							0	0	2
2	Sławomir KAMIŃSKI	?	AZS-AWF WARSZAWA SIOBUKAI	10		10				2	20	1

Matches

Match	White			Blue	Result	Time
1	Zbigniew TARNAWSKI	1	2	Sławomir KAMIŃSKI	00s1-10	0:55
2	Zbigniew TARNAWSKI	1	2	Sławomir KAMIŃSKI	00s1-10	1:10
3	Zbigniew TARNAWSKI	1	2	Sławomir KAMIŃSKI		

Results

Pos	Name
1	Sławomir KAMIŃSKI, AZS-AWF WARSZAWA SIOBUKAI
2	Zbigniew TARNAWSKI, TS WISŁA KRAKÓW

MP 22.05.2021 Luboń M6+100

Competitors

Competitors: 2

#	Name	Grade	Club	1	2	1	2	1	2	Wins	Pts	Pos
1	Grzegorz MĘTECKI	?	KJ POLITECHNIKI BIAŁOSTOCKIEJ							0	0	2
2	Jacek CZARKOWSKI	?	WKS FLOTA GDYNIA	10		10				2	20	1

Matches

Match	White			Blue	Result	Time
1	Grzegorz MĘTECKI	1	2	Jacek CZARKOWSKI	00-10	0:10
2	Grzegorz MĘTECKI	1	2	Jacek CZARKOWSKI	00-10	0:11
3	Grzegorz MĘTECKI	1	2	Jacek CZARKOWSKI		

Results

Pos	Name
1	Jacek CZARKOWSKI, WKS FLOTA GDYNIA
2	Grzegorz MĘTECKI, KJ POLITECHNIKI BIAŁOSTOCKIEJ

MP 22.05.2021 Luboń M7-81

Competitors

Competitors: 1

#	Name	Grade	Club	1	Wins	Pts	Pos
1	Jarosław BURZYŃSKI	?	PIRANIE GRODZISK MAZOWIECKI				1

Matches

Match	White	Blue	Result	Time
-------	-------	------	--------	------

Results

Pos	Name
1	Jarosław BURZYŃSKI, PIRANIE GRODZISK MAZOWIECKI

MP 22.05.2021 Luboń M7-90

Competitors

Competitors: 3

#	Name	Grade	Club	1	2	3	Wins	Pts	Pos
1	Sławomir MATEJCZYK	?	KJ POLITECHNIKI BIAŁOSTOCKIEJ				1	10	2
2	Leopold MORZYK	?	UMKS ŻAK KIELCE	10		10	2	20	1
3	Mirosław KSOK	?	MKS JUVENIA WROCŁAW				0	0	3

Matches

Match	White			Blue	Result	Time
1	Sławomir MATEJCZYK	1	2	Leopold MORZYK	00s3-10s1	2:05
2	Sławomir MATEJCZYK	1	3	Mirosław KSOK	10-00	0:00
3	Leopold MORZYK	2	3	Mirosław KSOK	10-00	0:00

Results

Pos	Name
1	Leopold MORZYK, UMKS ŻAK KIELCE
2	Sławomir MATEJCZYK, KJ POLITECHNIKI BIAŁOSTOCKIEJ
3	Mirosław KSOK, MKS JUVENIA WROCŁAW

MP 22.05.2021 Luboń M7-100

Competitors

Competitors: 2

#	Name	Grade	Club	1	2	1	2	1	2	Wins	Pts	Pos
1	Andrzej GRZYWACZ	?	AZS Uniwersytet Warszawski	10		10				2	20	1
2	Artur CYMAN	?	WKS FLOTA GDYNIA							0	0	2

Matches

Match	White			Blue	Result	Time
1	Andrzej GRZYWACZ	1	2	Artur CYMAN	10-00s2	3:40
2	Andrzej GRZYWACZ	1	2	Artur CYMAN	10-00	0:00
3	Andrzej GRZYWACZ	1	2	Artur CYMAN		

Results

Pos	Name
1	Andrzej GRZYWACZ, AZS Uniwersytet Warszawski
2	Artur CYMAN, WKS FLOTA GDYNIA

MP 22.05.2021 Luboń M8-81

Competitors

Competitors: 1

#	Name	Grade	Club	1	Wins	Pts	Pos
1	Lesław LICZNAR	?	KS GWARDIA OPOLE		0	0	1

Matches

Match	White	Blue	Result	Time
-------	-------	------	--------	------

Results

Pos	Name
1	Lesław LICZNAR, KS GWARDIA OPOLE

MP 22.05.2021 Luboń M8+100

Competitors

Competitors: 1

#	Name	Grade	Club	1	Wins	Pts	Pos
1	Zbigniew MAZUR	?	AZS Gliwice		0	0	1

Matches

Match	White	Blue	Result	Time
-------	-------	------	--------	------

Results

Pos	Name
1	Zbigniew MAZUR, AZS Gliwice

MP 22.05.2021 Luboń M9-66

Competitors

Competitors: 1

#	Name	Grade	Club	1	Wins	Pts	Pos
1	Ryszard WICHAN	?	AZS UNIWERSYTET ŁÓDZKI		0	0	1

Matches

Match	White	Blue	Result	Time
-------	-------	------	--------	------

Results

Pos	Name
1	Ryszard WICHAN, AZS UNIWERSYTET ŁÓDZKI

MP 22.05.2021 Luboń M9-90

Competitors

Competitors: 1

#	Name	Grade	Club	1	Wins	Pts	Pos
1	Zbigniew KAZNOCHA	?	KEJZA TEAM RYBNIK		0	0	1

Matches

Match	White	Blue	Result	Time
-------	-------	------	--------	------

Results

Pos	Name
1	Zbigniew KAZNOCHA, KEJZA TEAM RYBNIK

MP 22.05.2021 Luboń F2AM1-57

Competitors

Competitors: 1

#	Name	Grade	Club	1	Wins	Pts	Pos
1	Ilona TATAROWSKA	?	SV 08/29 FRIEDRICHSFELD		0	0	1

Matches

Match	White	Blue	Result	Time
-------	-------	------	--------	------

Results

Pos	Name
1	Ilona TATAROWSKA, SV 08/29 FRIEDRICHSFELD

MP 22.05.2021 Luboń F2AM2-57

Competitors

Competitors: 1

#	Name	Grade	Club	1	Wins	Pts	Pos
1	Agnieszka PATAŁA	?	MKS JUVENIA WROCLAW		0	0	1

Matches

Match	White	Blue	Result	Time
-------	-------	------	--------	------

Results

Pos	Name
1	Agnieszka PATAŁA, MKS JUVENIA WROCLAW

MP 22.05.2021 Luboń F2AM1-63

Competitors

Competitors: 2

#	Name	Grade	Club	1	2	1	2	1	2	Wins	Pts	Pos
1	Anna JAGIEŁŁO	?	JUDO LEGIA WARSZAWA							0	0	2
2	Agata CZAŁBOWSKA	?	JUDO LEGIA WARSZAWA	10						2	20	1

Matches

Match	White			Blue	Result	Time
1	Anna JAGIEŁŁO	1	2	Agata CZAŁBOWSKA	00-10	2:59
2	Anna JAGIEŁŁO	1	2	Agata CZAŁBOWSKA	00-10	1:56
3	Anna JAGIEŁŁO	1	2	Agata CZAŁBOWSKA		

Results

Pos	Name
1	Agata CZAŁBOWSKA, JUDO LEGIA WARSZAWA
2	Anna JAGIEŁŁO, JUDO LEGIA WARSZAWA

MP 22.05.2021 Luboń F2AM2-63

Competitors: 0

MP 22.05.2021 Luboń F2AM1-70

Competitors

Competitors: 3

#	Name	Grade	Club	1	2	3	Wins	Pts	Pos
1	Edyta SŁODOWNIK	?	KLUB JUDO CHOJRAK				0	0	3
2	Aleksandra KRÓL	?	TS WISŁA KRAKÓW	10			1	10	2
3	Anna GRZECHNIK	?	KUMA JUDO WARSZAWA	10	10		2	20	1

Matches

Match	White			Blue	Result	Time
1	Edyta SŁODOWNIK	1	2	Aleksandra KRÓL	00s1-10s1	1:52
2	Edyta SŁODOWNIK	1	3	Anna GRZECHNIK	00-10	0:34
3	Aleksandra KRÓL	2	3	Anna GRZECHNIK	01s1-10	4:00

Results

Pos	Name
1	Anna GRZECHNIK, KUMA JUDO WARSZAWA
2	Aleksandra KRÓL, TS WISŁA KRAKÓW
3	Edyta SŁODOWNIK, KLUB JUDO CHOJRAK

MP 22.05.2021 Luboń F2AM2-78

Competitors: 0

MP 22.05.2021 Luboń F2AM1+78

Competitors

Competitors: 1

#	Name	Grade	Club	1	Wins	Pts	Pos
1	Agnieszka OLEJNIK	?	JUDO LEGIA WARSZAWA		0	0	1

Matches

Match	White	Blue	Result	Time
-------	-------	------	--------	------

Results

Pos	Name
1	Agnieszka OLEJNIK, JUDO LEGIA WARSZAWA

MP 22.05.2021 Luboń M2AM1-66

Competitors

Competitors: 2

#	Name	Grade	Club	1	2	1	2	1	2	Wins	Pts	Pos
1	Konrad SZYDŁO	?	MASTERS KROSNO		10		10			2	20	1
2	Mankhazul MASHBAT	?	UKS SENSHI OLSZTYN							0	0	2

Matches

Match	White			Blue	Result	Time
1	Konrad SZYDŁO	1	2	Mankhazul MASHBAT	10-00	0:10
2	Konrad SZYDŁO	1	2	Mankhazul MASHBAT	10-00	1:05
3	Konrad SZYDŁO	1	2	Mankhazul MASHBAT		

Results

Pos	Name
1	Konrad SZYDŁO, MASTERS KROSNO
2	Mankhazul MASHBAT, UKS SENSHI OLSZTYN

MP 22.05.2021 Luboń M2AM2-66

Competitors

Competitors: 1

#	Name	Grade	Club	1	Wins	Pts	Pos
1	Sławomir JÓŹWIAK	?	OSIR WARSZAWA TARGÓWEK		0	0	1

Matches

Match	White	Blue	Result	Time
-------	-------	------	--------	------

Results

Pos	Name
1	Sławomir JÓŹWIAK, OSIR WARSZAWA TARGÓWEK

MP 22.05.2021 Luboń M2AM1-73

Competitors A

Competitors: 8

#	Name	Grade	Club	1	2	3	4	Wins	Pts	Pos
1	Grzegorz RUCIŃSKI	?	JUDO LEGIA WARSZAWA		1	10		2	11	2
2	Tomasz SKUBISZ	?	KJ RAION PRUSZCZ GDANSKI					0	0	4
3	Artur PEKAŁA	?	KEJZA TEAM RYBNIK		10			1	10	3
4	Łukasz BŁASZCZYK	?	KUMA JUDO WARSZAWA	10	10	10		3	30	1

Matches A

Match	White	Blue	Result	Time
1	Grzegorz RUCIŃSKI 1 2	Tomasz SKUBISZ	01s2-00s2	4:00
3	Artur PEKAŁA 3 4	Łukasz BŁASZCZYK	01-10	1:03
5	Grzegorz RUCIŃSKI 1 3	Artur PEKAŁA	10-00	0:32
7	Tomasz SKUBISZ 2 4	Łukasz BŁASZCZYK	00-10	0:40
9	Grzegorz RUCIŃSKI 1 4	Łukasz BŁASZCZYK	00-10	2:37
11	Tomasz SKUBISZ 2 3	Artur PEKAŁA	00s1-10	1:36

Competitors B

#	Name	Grade	Club	5	6	7	8	Wins	Pts	Pos
5	Michał SOBIESIAK	?	UKS SPARTAKUS LUBLIN	10	10	10		3	30	1
6	Wojciech BRYŚ	?	TORNADO TEAM ŚWIĘTOCHŁOWICE					1	10	3
7	Michał KOWALSKI	?	JUDO SMECZ POBIEDZISKA	10		10		2	20	2
8	Jarosław SAŁEK	?	UKS JUDO KRAKÓW					0	0	4

Matches B

Match	White	Blue	Result	Time
2	Michał SOBIESIAK 5 6	Wojciech BRYŚ	10-00	0:15
4	Michał KOWALSKI 7 8	Jarosław SAŁEK	10-00s1	1:39
6	Michał SOBIESIAK 5 7	Michał KOWALSKI	10-00	0:37
8	Wojciech BRYŚ 6 8	Jarosław SAŁEK	10s2-01	2:17
10	Michał SOBIESIAK 5 8	Jarosław SAŁEK	11-00	0:59
12	Wojciech BRYŚ 6 7	Michał KOWALSKI	00s2-10s2	1:24

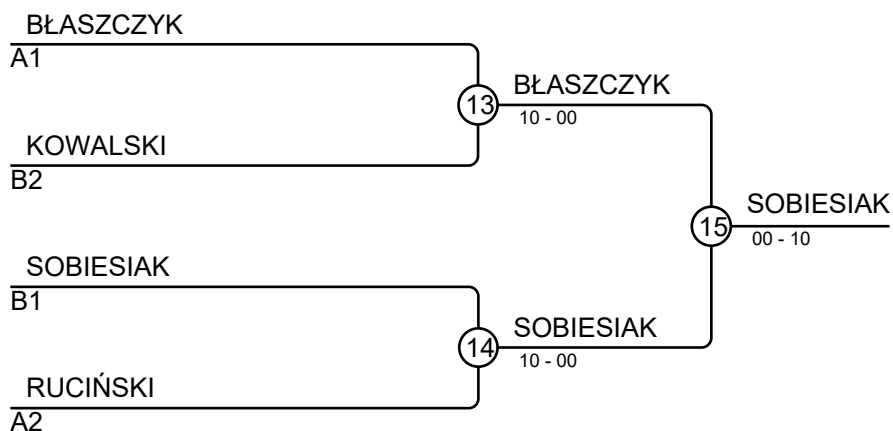

Results

Pos	Name
1	Michał SOBIESIAK, UKS SPARTAKUS LUBLIN
2	Łukasz BŁASZCZYK, KUMA JUDO WARSZAWA
3	Michał KOWALSKI, JUDO SMECZ POBIEDZISKA
3	Grzegorz RUCIŃSKI, JUDO LEGIA WARSZAWA

MP 22.05.2021 Luboń M2AM2-73

Competitors

Competitors: 5

#	Name	Grade	Club	1	2	3	4	5	Wins	Pts	Pos
1	Konrad GRABIAK	?	GALEON GDYNIA			10	10	10	3	30	1
2	Kamil BŁAŻYCA	?	KJ KOKA JASTRZĘBIE	10		10			2	20	4
3	Jurek SNOPEK	?	JAGUAR GDAŃSK						0	0	5
4	Łukasz IHNATOWICZ	?	KS JUDO TEAM MASTERS		10	10		10	3	30	2
5	Maciej GAWLIK	?	KS JUDO TEAM MASTERS		10	10			2	20	3

Matches

Match	White	Blue	Result	Time
1	Łukasz IHNATOWICZ 4 5	Maciej GAWLIK	10-00	0:37
2	Konrad GRABIAK 1 2	Kamil BŁAŻYCA	00-10	0:21
3	Jurek SNOPEK 3 4	Łukasz IHNATOWICZ	00-10s1	0:59
4	Konrad GRABIAK 1 5	Maciej GAWLIK	10-00	4:29
5	Kamil BŁAŻYCA 2 3	Jurek SNOPEK	10-00	0:42
6	Konrad GRABIAK 1 4	Łukasz IHNATOWICZ	10-00	0:38
7	Jurek SNOPEK 3 5	Maciej GAWLIK	00-10	1:21
8	Kamil BŁAŻYCA 2 4	Łukasz IHNATOWICZ	00-10	0:00
9	Konrad GRABIAK 1 3	Jurek SNOPEK	10-01	0:21
10	Kamil BŁAŻYCA 2 5	Maciej GAWLIK	00-10	0:00

Results

Pos	Name
1	Konrad GRABIAK, GALEON GDYNIA
2	Łukasz IHNATOWICZ, KS JUDO TEAM MASTERS
3	Maciej GAWLIK, KS JUDO TEAM MASTERS
4	Kamil BŁAŻYCA, KJ KOKA JASTRZĘBIE
5	Jurek SNOPEK, JAGUAR GDAŃSK

MP 22.05.2021 Luboń M2AM1-81

Competitors: 18

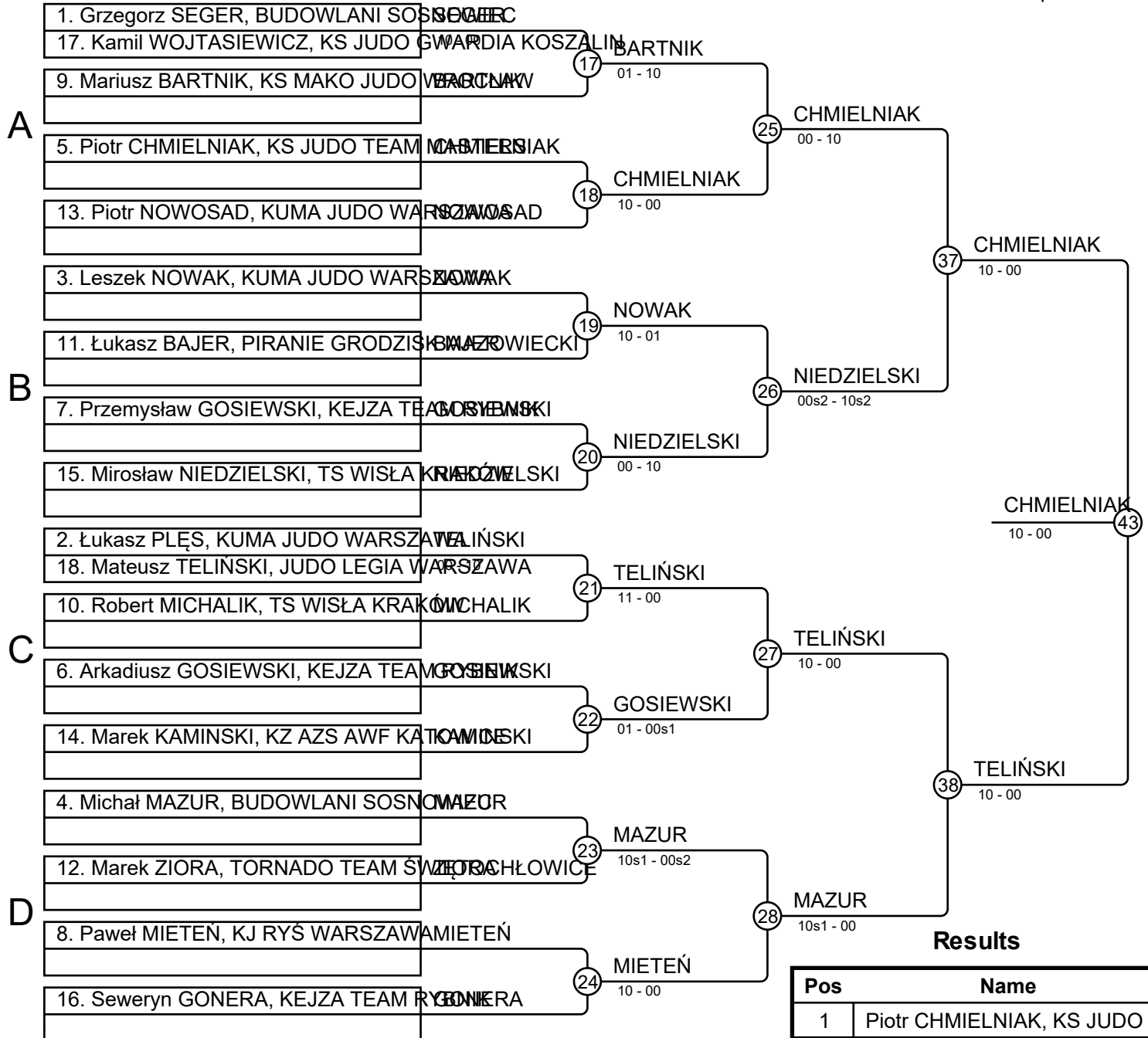

Results

Pos	Name
1	Piotr CHMIELNIAK, KS JUDO TEAM MASTERSIAK
2	Mateusz TELIŃSKI, JUDO LEGIA WARSZAWA
3	Michał MAZUR, BUDOWLANI SOSNOLEC
3	Mirosław NIEDZIELSKI, TS WISŁA KRAKÓW
5	Przemysław GOSIEWSKI, KEJZA TEAM GOSIEMSKI
5	Paweł MIETEŃ, KJ RYŚ WARSZAWA
7	Piotr NOWOSAD, KUMA JUDO WARSZAWA
7	Arkadiusz GOSIEWSKI, KEJZA TEAM GOSIEMSKI

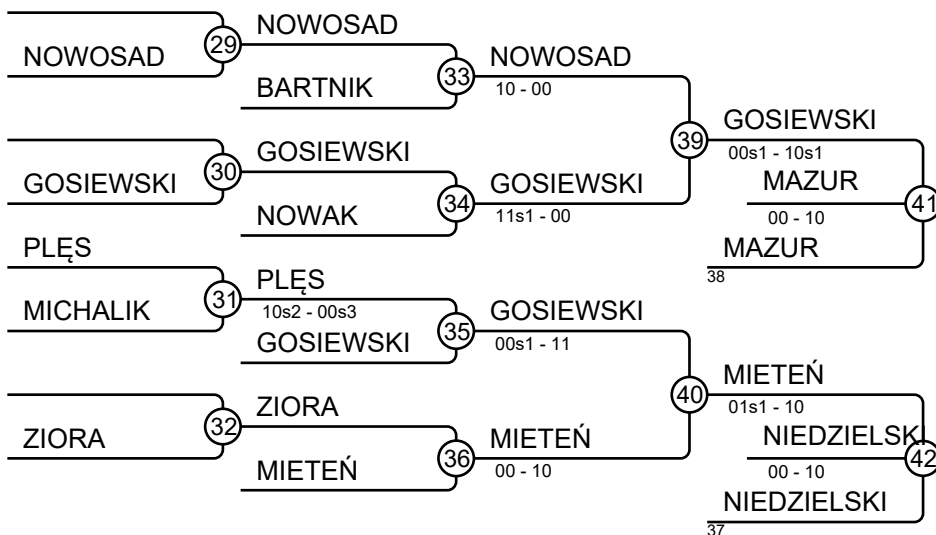

MP 22.05.2021 Luboń M2AM2-81

Competitors

Competitors: 4

#	Name	Grade	Club	1	2	3	4	Wins	Pts	Pos
1	Marcin MASŁOŃ	?	UKS SENSHI OLSZTYN					0	0	4
2	Piotr CZECHOWICZ	?	KZ AZS AWF KATOWICE	10				1	10	3
3	Vitali KARPIK	?	UKS SADYBA	10	10		10	3	30	1
4	Konrad TAJDUŚ	?	TS WISŁA KRAKÓW	10	10			2	20	2

Matches

Match	White	Blue	Result	Time
1	Marcin MASŁOŃ 1 2	Piotr CZECHOWICZ	00-10	0:56
2	Vitali KARPIK 3 4	Konrad TAJDUŚ	11-00	1:08
3	Marcin MASŁOŃ 1 3	Vitali KARPIK	00-10	0:31
4	Piotr CZECHOWICZ 2 4	Konrad TAJDUŚ	00-10	1:23
5	Marcin MASŁOŃ 1 4	Konrad TAJDUŚ	01-10	2:13
6	Piotr CZECHOWICZ 2 3	Vitali KARPIK	00-10s1	1:35

Results

Pos	Name
1	Vitali KARPIK, UKS SADYBA
2	Konrad TAJDUŚ, TS WISŁA KRAKÓW
3	Piotr CZECHOWICZ, KZ AZS AWF KATOWICE
4	Marcin MASŁOŃ, UKS SENSHI OLSZTYN

MP 22.05.2021 Luboń M2AM1-90

Competitors: 13

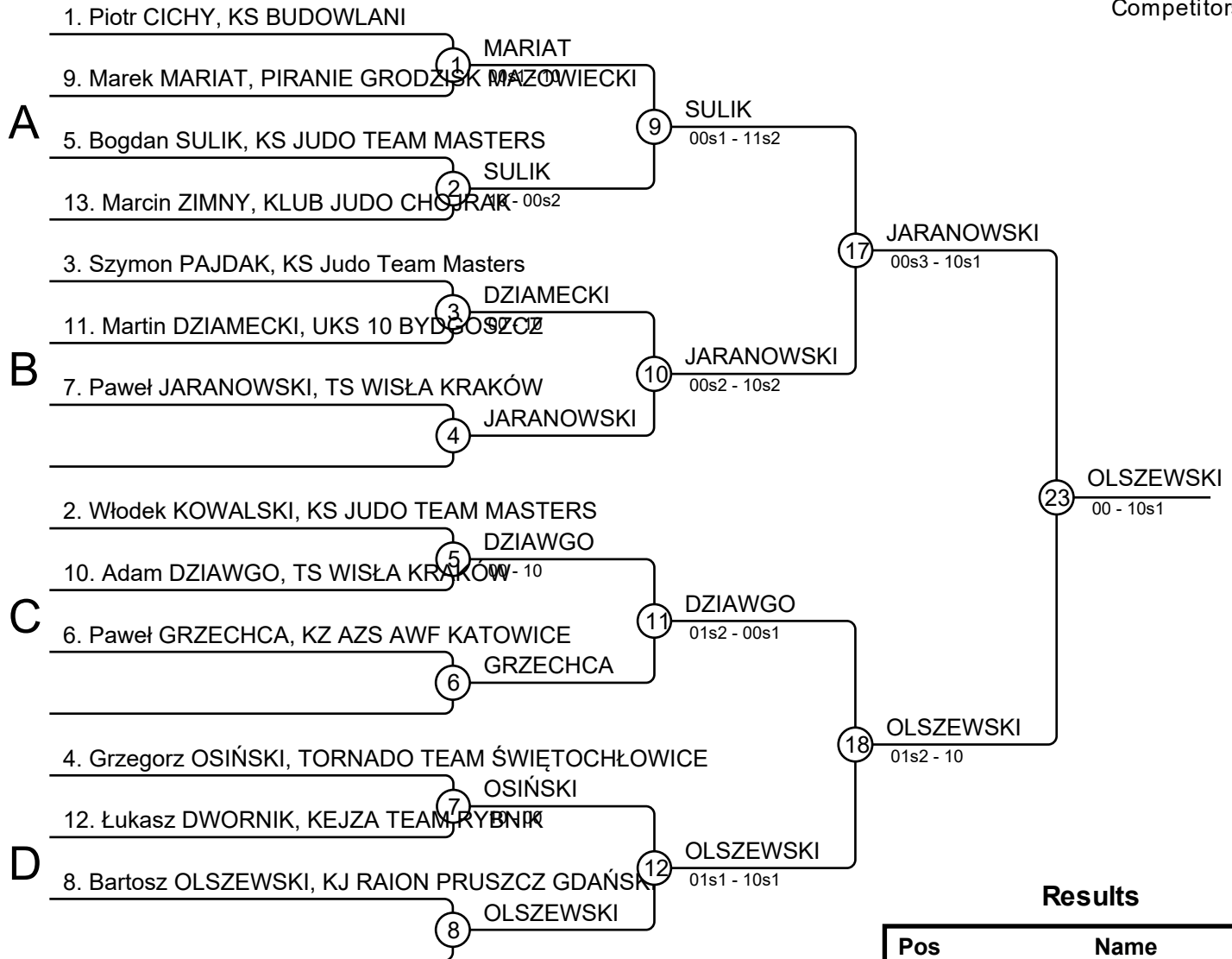

Results

Pos	Name
1	Bartosz OLSZEWSKI, KJ RAION PRUSZCZ GDAŃSK
2	Paweł JARANOWSKI, TS WISŁA KRAKÓW
3	Adam DZIAWGO, TS WISŁA KRAKÓW
3	Grzegorz OSIŃSKI, TORNADO TEAM ŚWIĘTOCHŁOWICE
5	Marcin ZIMNY, KLUB JUDO CHOJRAK
5	Bogdan SULIK, KS JUDO TEAM MASTERS
7	Martin DZIAMECKI, UKS 10 BYDGOSZCZ
7	Paweł GRZECHCA, KZ AZS AWF KATOWICE

MP 22.05.2021 Luboń M2AM2-90

Competitors A

Competitors: 7

#	Name	Grade	Club	1	2	3	4	Wins	Pts	Pos
1	Rafał KOSIŃSKI	?	UKS JUDO KRAKÓW					0	0	4
2	Damian JAKUBOWSKI	?	TORNADO TEAM ŚWIĘTOCHŁOWICE	10				3	21	1
3	Wojciech ADAMUS	?	KS JUDO TEAM MASTERS				10	2	20	2
4	Łukasz FURMANEK	?	UMKS ŻAK KIELCE	10				1	10	3

Matches A

Match	White	Blue	Result	Time
1	Rafał KOSIŃSKI 1 2	Damian JAKUBOWSKI	00-10	2:57
2	Wojciech ADAMUS 3 4	Łukasz FURMANEK	11-01s1	2:54
4	Rafał KOSIŃSKI 1 3	Wojciech ADAMUS	00s1-10	2:42
5	Damian JAKUBOWSKI 2 4	Łukasz FURMANEK	10s2-00s3	3:10
7	Rafał KOSIŃSKI 1 4	Łukasz FURMANEK	00s1-10	1:55
8	Damian JAKUBOWSKI 2 3	Wojciech ADAMUS	01-00	4:00

Competitors B

#	Name	Grade	Club	5	6	7	Wins	Pts	Pos
5	Piotr JAROCKI	?	UKS JUDO KRAKÓW				0	0	3
6	Oleksandr SIEDIN	?	UKS JUDO KRAKÓW	10			1	10	2
7	Mateusz NICGÓRSKI	?	KZ AZS AWF KATOWICE	10	1		2	11	1

Matches B

Match	White	Blue	Result	Time
3	Piotr JAROCKI 5 6	Oleksandr SIEDIN	00-10	2:04
6	Piotr JAROCKI 5 7	Mateusz NICGÓRSKI	00-10	0:39
9	Oleksandr SIEDIN 6 7	Mateusz NICGÓRSKI	00-01	4:00

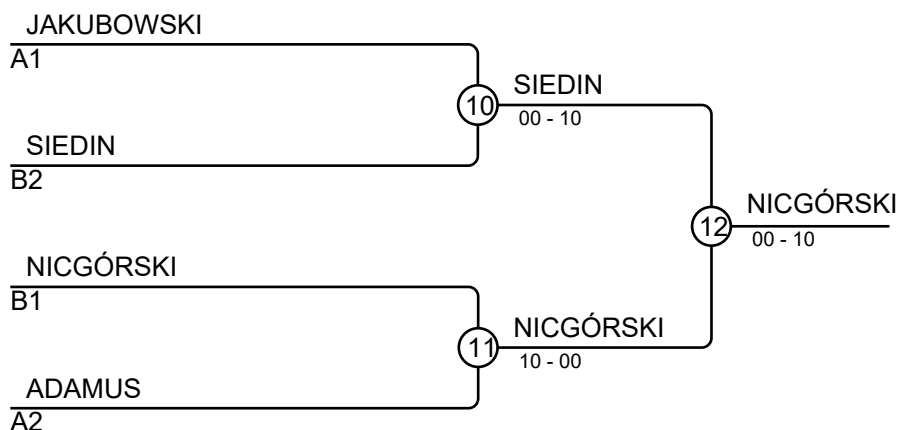

Results

Pos	Name
1	Mateusz NICGÓRSKI, KZ AZS AWF KATOWICE
2	Oleksandr SIEDIN, UKS JUDO KRAKÓW
3	Damian JAKUBOWSKI, TORNADO TEAM ŚWIĘTOCHŁOWICE
3	Wojciech ADAMUS, KS JUDO TEAM MASTERS

MP 22.05.2021 Luboń M2AM1-100

Competitors A

Competitors: 7

#	Name	Grade	Club	1	2	3	4	Wins	Pts	Pos
1	Marcin MECNER	?	KLUB JUDO CHOJRAK		10	10	10	3	30	1
2	Andrzej FRANIA	?	KS JUDO TEAM MASTERS					0	0	4
3	Marek NAGÓRSKI	?	GALEON GDYNIA		10			1	10	3
4	Michał CZARNOTA	?	KEJZA TEAM RYBNIK		1	10		2	11	2

Matches A

Match	White	Blue	Result	Time
1	Marcin MECNER 1 2	Andrzej FRANIA	10-00s1	0:47
2	Marek NAGÓRSKI 3 4	Michał CZARNOTA	00-10	0:53
4	Marcin MECNER 1 3	Marek NAGÓRSKI	10-00	1:08
5	Andrzej FRANIA 2 4	Michał CZARNOTA	00-01	3:11
7	Marcin MECNER 1 4	Michał CZARNOTA	10-01	2:56
8	Andrzej FRANIA 2 3	Marek NAGÓRSKI	00-10s1	2:02

Competitors B

#	Name	Grade	Club	5	6	7	Wins	Pts	Pos
5	Piotr KORCIPA	?	BUDOWLANI SOSNOWIEC			10	1	10	2
6	Krzysztof GOCCMAN	?	KUMA JUDO WARSZAWA	10		10	2	20	1
7	Maciej BRODALA	?	KS JUDO TEAM MASTERS				0	0	3

Matches B

Match	White	Blue	Result	Time
3	Piotr KORCIPA 5 6	Krzysztof GOCCMAN	00-10	0:32
6	Piotr KORCIPA 5 7	Maciej BRODALA	10-00	0:31
9	Krzysztof GOCCMAN 6 7	Maciej BRODALA	10-00	0:32

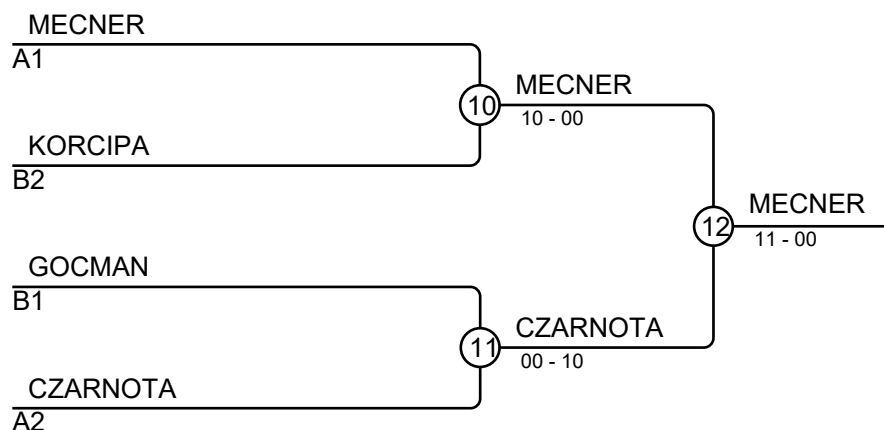

Results

Pos	Name
1	Marcin MECNER, KLUB JUDO CHOJRAK
2	Michał CZARNOTA, KEJZA TEAM RYBNIK
3	Piotr KORCIPA, BUDOWLANI SOSNOWIEC
3	Krzysztof GOCCMAN, KUMA JUDO WARSZAWA

MP 22.05.2021 Luboń M2AM2-100

Competitors

Competitors: 4

#	Name	Grade	Club	1	2	3	4	Wins	Pts	Pos
1	Rafał PACHOLEC	?	UMKS ŻAK KIELCE		10		10	2	20	2
2	Mariusz KWIOTEK	?	UKS PAWŁOWICE				10	1	10	3
3	Patryk MANULIK	?	MKS Juvenia Wrocław	10	10		10	3	30	1
4	Sebastian BARSZCZEWSKI	?	KJ KOKA JASTRZĘBIE					0	0	4

Matches

Match	White	Blue	Result	Time
1	Rafał PACHOLEC 1 2	Mariusz KWIOTEK	10-00	0:36
2	Patryk MANULIK 3 4	Sebastian BARSZCZEWSKI	10-00	0:13
3	Rafał PACHOLEC 1 3	Patryk MANULIK	00-10	0:35
4	Mariusz KWIOTEK 2 4	Sebastian BARSZCZEWSKI	10-00	0:52
5	Rafał PACHOLEC 1 4	Sebastian BARSZCZEWSKI	11-00	0:28
6	Mariusz KWIOTEK 2 3	Patryk MANULIK	00-10	0:22

Results

Pos	Name
1	Patryk MANULIK, MKS Juvenia Wrocław
2	Rafał PACHOLEC, UMKS ŻAK KIELCE
3	Mariusz KWIOTEK, UKS PAWŁOWICE
4	Sebastian BARSZCZEWSKI, KJ KOKA JASTRZĘBIE

MP 22.05.2021 Luboń M2AM1+100

Competitors

Competitors: 4

#	Name	Grade	Club	1	2	3	4	Wins	Pts	Pos
1	Artur KALITA	?	BUDOWLANI SOSNOWIEC					0	0	4
2	Arkadiusz BEREK	?	KEJZA TEAM RYBNIK	10		10	10	3	30	1
3	Łukasz ZIÓŁKOWSKI	?	GŁOGOWSKI KLUB JUDO	00			10	2	20	2
4	Adrian JAEDTKA	?	KS JUDO TEAM MASTERS	10				1	10	3

Matches

Match	White	Blue	Result	Time
1	Artur KALITA	1 2 Arkadiusz BEREK	00-10	0:20
2	Łukasz ZIÓŁKOWSKI	3 4 Adrian JAEDTKA	10-00s1	0:25
3	Artur KALITA	1 3 Łukasz ZIÓŁKOWSKI	00-10	0:00
4	Arkadiusz BEREK	2 4 Adrian JAEDTKA	10-00	0:28
5	Artur KALITA	1 4 Adrian JAEDTKA	00-10	0:00
6	Arkadiusz BEREK	2 3 Łukasz ZIÓŁKOWSKI	10s1-01s3	3:40

Results

Pos	Name
1	Arkadiusz BEREK, KEJZA TEAM RYBNIK
2	Łukasz ZIÓŁKOWSKI, GŁOGOWSKI KLUB JUDO
3	Adrian JAEDTKA, KS JUDO TEAM MASTERS
4	Artur KALITA, BUDOWLANI SOSNOWIEC

MP 22.05.2021 Luboń M2AM2+100

Competitors

Competitors: 3

#	Name	Grade	Club	1	2	3	Wins	Pts	Pos
1	Tomasz WELTROWSKI	?	KJ GRIZZLY GDAŃSK		10	10	2	20	1
2	Piotr ŻÓŁKIEWICZ	?	JAGUAR GDAŃSK			10	1	10	2
3	Michał GÓRA	?	Ippon Jarocin				0	0	3

Matches

Match	White		Blue	Result	Time
1	Tomasz WELTROWSKI	1 2	Piotr ŻÓŁKIEWICZ	10s1-00	0:43
2	Tomasz WELTROWSKI	1 3	Michał GÓRA	10-00	0:22
3	Piotr ŻÓŁKIEWICZ	2 3	Michał GÓRA	10s1-00s1	1:32

Results

Pos	Name
1	Tomasz WELTROWSKI, KJ GRIZZLY GDAŃSK
2	Piotr ŻÓŁKIEWICZ, JAGUAR GDAŃSK
3	Michał GÓRA, Ippon Jarocin